

# **INSTRUCTION BOOK**

## **OIL-INJECTED ROTARY SCREW COMPRESSORS**

GA 30+, GA 37, GA 45





# Atlas Copco

## Oil-injected rotary screw compressors

GA 30+, GA 37, GA 45

From following serial No. onwards: API 571 000

### Instruction book

Original instructions

#### **COPYRIGHT NOTICE**

Any unauthorized use or copying of the contents or any part thereof is prohibited.

This applies in particular to trademarks, model denominations, part numbers and drawings.

This instruction book is valid for CE as well as non-CE labelled machines. It meets the requirements for instructions specified by the applicable European directives as identified in the Declaration of Conformity.

2017 - 09

No. 2920 7180 31

[www.atlascopco.com](http://www.atlascopco.com)



## Table of contents

<b>1</b>	<b>Safety precautions.....</b>	<b>7</b>
1.1	SAFETY ICONS.....	7
1.2	GENERAL SAFETY PRECAUTIONS.....	7
1.3	SAFETY PRECAUTIONS DURING INSTALLATION.....	8
1.4	SAFETY PRECAUTIONS DURING OPERATION.....	9
1.5	SAFETY PRECAUTIONS DURING MAINTENANCE OR REPAIR.....	10
<b>2</b>	<b>General description.....</b>	<b>13</b>
2.1	INTRODUCTION.....	13
2.2	AIR AND OIL CIRCUIT.....	18
2.3	COOLING SYSTEM.....	21
2.4	CONDENSATE SYSTEM.....	21
2.5	REGULATING SYSTEM.....	26
2.6	ELECTRICAL SYSTEM.....	27
2.7	AIR DRYER.....	28
<b>3</b>	<b>Elektronik™ controller.....</b>	<b>30</b>
3.1	ELEKTRONIK™ CONTROLLER.....	30
3.2	CONTROL PANEL.....	31
3.3	ICONS USED ON THE DISPLAY.....	32
3.4	MAIN SCREEN.....	34
3.5	SHUT-DOWN WARNING.....	35
3.6	SHUT-DOWN.....	36
3.7	SERVICE WARNING.....	38
3.8	SCROLLING THROUGH ALL SCREENS.....	39
3.9	CALLING UP TEMPERATURES.....	43
3.10	CALLING UP RUNNING HOURS.....	44
3.11	CALLING UP MOTOR STARTS.....	45

3.12	CALLING UP MODULE HOURS.....	45
3.13	CALLING UP LOADING HOURS.....	46
3.14	CALLING UP LOAD RELAY.....	46
3.15	CALLING UP/RESETTING THE SERVICE TIMER .....	47
3.16	SELECTION BETWEEN LOCAL, REMOTE OR LAN CONTROL.....	48
3.17	CALLING UP/MODIFYING CAN ADDRESS.....	48
3.18	CALLING UP/MODIFYING IP, GATEWAY AND SUBNETMASK.....	50
3.19	CALLING UP/MODIFYING PRESSURE BAND SETTINGS.....	51
3.20	MODIFYING THE PRESSURE BAND SELECTION.....	53
3.21	CALLING UP/MODIFYING SERVICE TIMER SETTINGS.....	53
3.22	CALLING UP/MODIFYING THE UNIT OF TEMPERATURE.....	54
3.23	CALLING UP/MODIFYING UNIT OF PRESSURE.....	54
3.24	ACTIVATING AUTOMATIC RESTART AFTER VOLTAGE FAILURE.....	54
3.25	SELECTION BETWEEN Y-D OR DOL STARTING.....	55
3.26	CALLING UP MODIFYING LOAD DELAY TIME.....	56
3.27	CALLING UP MODIFYING MINIMUM STOP TIME.....	56
3.28	ACTIVATING PASSWORD PROTECTION.....	57
3.29	ACTIVATE LOAD/UNLOAD REMOTE PRESSURE SENSING.....	57
3.30	CALLING UP/MODIFYING PROTECTION SETTINGS.....	58
3.31	TEST SCREENS.....	60
3.32	WEB SERVER.....	61
3.33	PROGRAMMABLE SETTINGS.....	68
<b>4</b>	<b>Elektronikon™ Graphic controller.....</b>	<b>72</b>
4.1	CONTROLLER.....	72
4.2	CONTROL PANEL.....	74
4.3	ICONS USED.....	75
4.4	MAIN SCREEN.....	78
4.5	CALLING UP MENUS.....	82
4.6	INPUTS MENU.....	83

4.7	OUTPUTS MENU.....	86
4.8	COUNTERS.....	87
4.9	CONTROL MODE SELECTION.....	88
4.10	SERVICE MENU.....	90
4.11	SETPOINT MENU.....	94
4.12	EVENT HISTORY MENU.....	96
4.13	MODIFYING GENERAL SETTINGS.....	97
4.14	INFO MENU.....	98
4.15	WEEK TIMER MENU.....	99
4.16	TEST MENU.....	108
4.17	USER PASSWORD MENU.....	109
4.18	WEB SERVER.....	110
4.19	PROGRAMMABLE SETTINGS.....	118
<b>5</b>	<b>Energy recovery (optional).....</b>	<b>122</b>
5.1	ENERGY RECOVERY UNIT.....	122
5.2	ENERGY RECOVERY SYSTEMS.....	123
5.3	OPERATION.....	124
5.4	MAINTENANCE.....	126
5.5	ENERGY RECOVERY DATA.....	127
5.6	COOLING WATER REQUIREMENTS.....	129
<b>6</b>	<b>Installation.....</b>	<b>134</b>
6.1	DIMENSION DRAWINGS.....	134
6.2	INSTALLATION PROPOSAL.....	134
6.3	ELECTRICAL CONNECTIONS.....	138
6.4	PICTOGRAPHS.....	140
<b>7</b>	<b>Operating instructions.....</b>	<b>142</b>
7.1	INITIAL START-UP.....	142



7.2	BEFORE STARTING.....	145
7.3	STARTING .....	147
7.4	DURING OPERATION.....	148
7.5	CHECKING THE DISPLAY.....	150
7.6	STOPPING .....	151
7.7	TAKING OUT OF OPERATION.....	152
<b>8</b>	<b>Maintenance.....</b>	<b>154</b>
8.1	PREVENTIVE MAINTENANCE SCHEDULE.....	154
8.2	OIL SPECIFICATIONS.....	156
8.3	DRIVE MOTOR .....	157
8.4	AIR FILTER.....	158
8.5	OIL AND OIL FILTER CHANGE.....	159
8.6	COOLERS.....	160
8.7	SAFETY VALVES.....	162
8.8	DRYER MAINTENANCE INSTRUCTIONS.....	162
8.9	SERVICE KITS.....	163
8.10	STORAGE AFTER INSTALLATION.....	164
8.11	DISPOSAL OF USED MATERIAL.....	164
<b>9</b>	<b>Problem solving.....</b>	<b>165</b>
<b>10</b>	<b>Technical data.....</b>	<b>169</b>
10.1	READINGS ON DISPLAY.....	169
10.2	ELECTRIC CABLE SIZE AND FUSES.....	170
10.3	PROTECTION SETTINGS.....	176
10.4	DRYER SWITCHES.....	177
10.5	REFERENCE CONDITIONS AND LIMITATIONS.....	177
10.6	COMPRESSOR DATA.....	178
10.7	TECHNICAL DATA CONTROLLER.....	183

<b>11</b>	<b>Instructions for use.....</b>	<b>184</b>
<b>12</b>	<b>Guidelines for inspection.....</b>	<b>185</b>
<b>13</b>	<b>Pressure equipment directives.....</b>	<b>186</b>
<b>14</b>	<b>Declaration of conformity.....</b>	<b>187</b>

# 1 Safety precautions

## 1.1 Safety icons

### Explanation

	Danger to life
	Warning
	Important note

## 1.2 General safety precautions

1. The operator must employ safe working practices and observe all related work safety requirements and regulations.
2. If any of the following statements does not comply with the applicable legislation, the stricter of the two shall apply.
3. Installation, operation, maintenance and repair work must only be performed by authorized, trained, specialized personnel. The personnel should apply safe working practices by use of personal protection equipment, appropriate tools and defined procedures.
4. The compressor is not considered capable of producing air of breathing quality. For air of breathing quality, the compressed air must be adequately purified according to the applicable legislation and standards.
5. Before any maintenance, repair work, adjustment or any other non-routine checks:
  - Stop the machine
  - Press the emergency stop button
  - Switch off the voltage
  - Depressurize the machine
  - Lock Out - Tag Out (LOTO):
    - Open the power isolating switch and lock it with a personal lock
    - Tag the power isolating switch with the name of the service technician.
  - On units powered by a frequency converter, wait 10 minutes before starting any electrical repair.
  - Never rely on indicator lamps or electrical door locks before maintenance work, always disconnect and check with measuring device.

	If the machine is equipped with an automatic restart after voltage failure function and if this function is active, be aware that the machine will restart automatically when the power is restored if it was running when the power was interrupted!
---	---

6. Never play with compressed air. Do not apply the air to your skin or direct an air stream at people. Never use the air to clean dirt from your clothes. When using the air to clean equipment, do so with extreme caution and wear eye protection.
7. The owner is responsible for maintaining the unit in safe operating condition. Parts and accessories shall be replaced if unsuitable for safe operation.
8. It is prohibited to walk or stand on the unit or on its components.

9. If compressed air is used in the food industry and more specifically for direct food contact, it is recommended, for optimal safety, to use certified Class 0 compressors in combination with appropriate filtration depending on the application. Please contact your customer center for advice on specific filtration.

## 1.3 Safety precautions during installation



All responsibility for any damage or injury resulting from neglecting these precautions, or non observance of the normal caution and care required for installation, operation, maintenance and repair, even if not expressly stated, will be disclaimed by the manufacturer.

### Precautions during installation

1. The machine must only be lifted using suitable equipment in accordance with the applicable safety regulations. Loose or pivoting parts must be securely fastened before lifting. It is strictly forbidden to dwell or stay in the risk zone under a lifted load. Lifting acceleration and deceleration must be kept within safe limits. Wear a safety helmet when working in the area of overhead or lifting equipment.
2. The unit is designed for indoor use. If the unit is installed outdoors, special precautions must be taken; consult your supplier.
3. In case the device is a compressor, place the machine where the ambient air is as cool and clean as possible. If necessary, install a suction duct. Never obstruct the air inlet. Care must be taken to minimize the entry of moisture at the inlet air.
4. Any blanking flanges, plugs, caps and desiccant bags must be removed before connecting the pipes.
5. Air hoses must be of correct size and suitable for the working pressure. Never use frayed, damaged or worn hoses. Distribution pipes and connections must be of the correct size and suitable for the working pressure.
6. In case the device is a compressor, the aspirated air must be free of flammable fumes, vapors and particles, e.g. paint solvents, that can lead to internal fire or explosion.
7. In case the device is a compressor, arrange the air intake so that loose clothing worn by people cannot be drawn in.
8. Ensure that the discharge pipe from the compressor to the aftercooler or air net is free to expand under heat and that it is not in contact with or close to flammable materials.
9. No external force may be exerted on the air outlet valve; the connected pipe must be free of strain.
10. If remote control is installed, the machine must bear a clear sign stating: DANGER: This machine is remotely controlled and may start without warning.  
The operator has to make sure that the machine is stopped and depressurized and that the electrical isolating switch is open, locked and labelled with a temporary warning before any maintenance or repair. As a further safeguard, persons switching on or off remotely controlled machines shall take adequate precautions to ensure that there is no one checking or working on the machine. To this end, a suitable notice shall be affixed to the start equipment.
11. Air-cooled machines must be installed in such a way that an adequate flow of cooling air is available and that the exhausted air does not recirculate to the compressor air inlet or cooling air inlet.

12. The electrical connections must correspond to the applicable codes. The machines must be earthed and protected against short circuits by fuses in all phases. A lockable power isolating switch must be installed near the compressor.
13. On machines with automatic start/stop system or if the automatic restart function after voltage failure is activated, a sign stating "This machine may start without warning" must be affixed near the instrument panel.
14. In multiple compressor systems, manual valves must be installed to isolate each compressor. Non-return valves (check valves) must not be relied upon for isolating pressure systems.
15. Never remove or tamper with the safety devices, guards or insulation fitted on the machine. Every pressure vessel or auxiliary installed outside the machine to contain air above atmospheric pressure must be protected by a pressure relieving device or devices as required.
16. Piping or other parts with a temperature in excess of 70°C (158°F) and which may be accidentally touched by personnel in normal operation must be guarded or insulated. Other high temperature piping must be clearly marked.
17. For water-cooled machines, the cooling water system installed outside the machine has to be protected by a safety device with set pressure according to the maximum cooling water inlet pressure.
18. If the ground is not level or can be subject to variable inclination, consult the manufacturer.
19. If the device is a dryer and no free extinguishing system is present in the air net close to the dryer, safety valves must be installed in the vessels of the dryer.



Also consult following safety precautions: [Safety precautions during operation](#) and [Safety precautions during maintenance](#).  
 These precautions apply to machinery processing or consuming air or inert gas. Processing of any other gas requires additional safety precautions typical to the application which are not included herein.  
 Some precautions are general and cover several machine types and equipment; hence some statements may not apply to your machine.

## 1.4 Safety precautions during operation



All responsibility for any damage or injury resulting from neglecting these precautions, or non observance of the normal caution and care required for installation, operation, maintenance and repair, even if not expressly stated, will be disclaimed by the manufacturer.

### Precautions during operation

1. Never touch any piping or components of the machine during operation.
2. Use only the correct type and size of hose end fittings and connections. When blowing through a hose or air line, ensure that the open end is held securely. A free end will whip and may cause injury. Make sure that a hose is fully depressurized before disconnecting it.
3. Persons switching on remotely controlled machines shall take adequate precautions to ensure that there is no one checking or working on the machine. To this end, a suitable notice shall be affixed to the remote start equipment.
4. Never operate the machine when there is a possibility of taking in flammable or toxic fumes, vapors or particles.
5. Never operate the machine below or in excess of its limit ratings.

6. Keep all bodywork doors shut during operation. The doors may be opened for short periods only, e.g. to carry out routine checks. Wear ear protectors when opening a door. On machines without bodywork, wear ear protection in the vicinity of the machine.
7. People staying in environments or rooms where the sound pressure level reaches or exceeds 80 dB(A) shall wear ear protectors.
8. Periodically check that:
  - All guards are in place and securely fastened
  - All hoses and/or pipes inside the machine are in good condition, secure and not rubbing
  - No leaks occur
  - All fasteners are tight
  - All electrical leads are secure and in good order
  - Safety valves and other pressure relief devices are not obstructed by dirt or paint
  - Air outlet valve and air net, i.e. pipes, couplings, manifolds, valves, hoses, etc. are in good repair, free of wear or abuse
  - Air cooling filters of the electrical cabinet are not clogged
9. If warm cooling air from compressors is used in air heating systems, e.g. to warm up a workroom, take precautions against air pollution and possible contamination of the breathing air.
10. On water-cooled compressors using open circuit cooling towers, protective measures must be taken to avoid the growth of harmful bacteria such as Legionella pneumophila bacteria.
11. Do not remove any of, or tamper with, the sound-damping material.
12. Never remove or tamper with the safety devices, guards or insulations fitted on the machine. Every pressure vessel or auxiliary installed outside the machine to contain air above atmospheric pressure shall be protected by a pressure relieving device or devices as required.
13. Yearly inspect the air receiver. Minimum wall thickness as specified in the instruction book must be respected. Local regulations remain applicable if they are more strict.



Also consult following safety precautions: [Safety precautions during installation](#) and [Safety precautions during maintenance](#).  
 These precautions apply to machinery processing or consuming air or inert gas. Processing of any other gas requires additional safety precautions typical to the application which are not included herein.  
 Some precautions are general and cover several machine types and equipment; hence some statements may not apply to your machine.

## 1.5 Safety precautions during maintenance or repair



All responsibility for any damage or injury resulting from neglecting these precautions, or non observance of the normal caution and care required for installation, operation, maintenance and repair, even if not expressly stated, will be disclaimed by the manufacturer.

### Precautions during maintenance or repair

1. Always use the correct safety equipment (such as safety glasses, gloves, safety shoes, etc.).
2. Use only the correct tools for maintenance and repair work.

3. Use only genuine spare parts for maintenance or repair. The manufacturer will disclaim all damage or injuries caused by the use of non-genuine spare parts.
4. All maintenance work shall only be undertaken when the machine has cooled down.
5. A warning sign bearing a legend such as "Work in progress; do not start" shall be attached to the starting equipment.
6. Persons switching on remotely controlled machines shall take adequate precautions to ensure that there is no one checking or working on the machine. To this end, a suitable notice shall be affixed to the remote start equipment.
7. Close the compressor air outlet valve and depressurize the compressor before connecting or disconnecting a pipe.
8. Before removing any pressurized component, effectively isolate the machine from all sources of pressure and relieve the entire system of pressure.
9. Never use flammable solvents or carbon tetrachloride for cleaning parts. Take safety precautions against toxic vapors of cleaning liquids.
10. Scrupulously observe cleanliness during maintenance and repair. Keep dirt away by covering the parts and exposed openings with a clean cloth, paper or tape.
11. Never weld or perform any operation involving heat near the oil system. Oil tanks must be completely purged, e.g. by steam cleaning, before carrying out such operations. Never weld on, or in any way modify, pressure vessels.
12. Whenever there is an indication or any suspicion that an internal part of a machine is overheated, the machine shall be stopped but no inspection covers shall be opened before sufficient cooling time has elapsed; this to avoid the risk of spontaneous ignition of the oil vapor when air is admitted.
13. Never use a light source with open flame for inspecting the interior of a machine, pressure vessel, etc.
14. Make sure that no tools, loose parts or rags are left in or on the machine.
15. All regulating and safety devices shall be maintained with due care to ensure that they function properly. They may not be put out of action.
16. Before clearing the machine for use after maintenance or overhaul, check that operating pressures, temperatures and time settings are correct. Check that all control and shut-down devices are fitted and that they function correctly. If removed, check that the coupling guard of the compressor drive shaft has been reinstalled.
17. Every time the separator element is renewed, examine the discharge pipe and the inside of the oil separator vessel for carbon deposits; if excessive, the deposits should be removed.
18. Protect the motor, air filter, electrical and regulating components, etc. to prevent moisture from entering them, e.g. when steam cleaning.
19. Make sure that all sound-damping material and vibration dampers, e.g. damping material on the bodywork and in the air inlet and outlet systems of the compressor, is in good condition. If damaged, replace it by genuine material from the manufacturer to prevent the sound pressure level from increasing.
20. Never use caustic solvents which can damage materials of the air net, e.g. polycarbonate bowls.
21. **Only if applicable, the following safety precautions are stressed when handling refrigerant:**
  - Never inhale refrigerant vapors. Check that the working area is adequately ventilated; if required, use breathing protection.
  - Always wear special gloves. In case of refrigerant contact with the skin, rinse the skin with water. If liquid refrigerant contacts the skin through clothing, never tear off or remove the latter; flush abundantly with fresh water over the clothing until all refrigerant is flushed away; then seek medical first aid.



Also consult following safety precautions: [Safety precautions during installation](#) and [Safety precautions during operation](#).  
These precautions apply to machinery processing or consuming air or inert gas. Processing of any other gas requires additional safety precautions typical to the application which are not included herein.  
Some precautions are general and cover several machine types and equipment; hence some statements may not apply to your machine.

## 2 General description

### 2.1 Introduction

GA 30<sup>+</sup>, GA 37 and GA 45 are single-stage, oil-injected screw compressors, driven by an electric motor. The compressors are air cooled.

The compressors are controlled by an Elektronikon™ controller. GA 30<sup>+</sup> has an Elektronikon controller with graphical display, while the basic version of the GA 37 and GA 45 have a basic version of the Elektronikon controller. For the GA37 and the GA 45, the Elektronikon controller with graphical display is available as standard option.

The controller is fitted to the right hand door panel on the front side. An electric cabinet comprising the motor starter is located behind this panel.

The compressors are enclosed in a sound-insulated bodywork.

There are 2 versions of the compressor: Workplace Pack (without integrated dryer) and Workplace Full-Feature (with integrated dryer).

The dryer removes water from the compressed air by cooling the air to near freezing point.

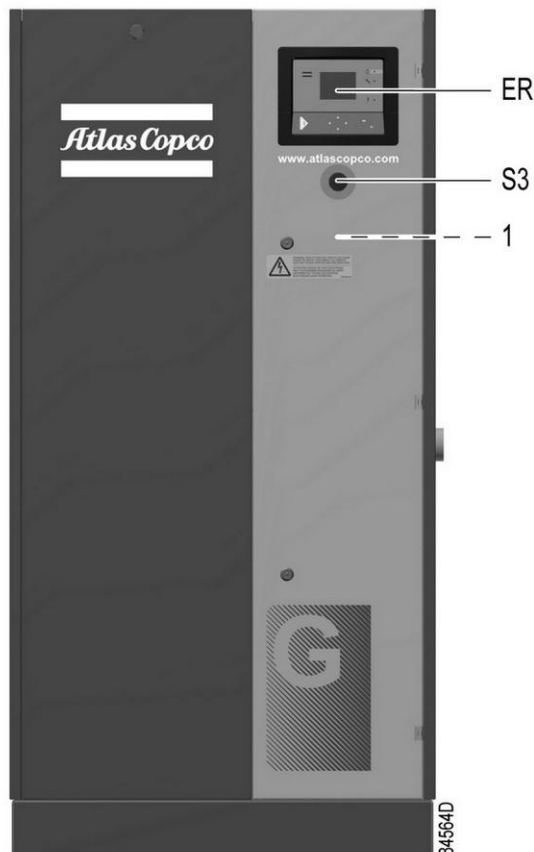

Front view, GA 30<sup>+</sup> up to GA 45

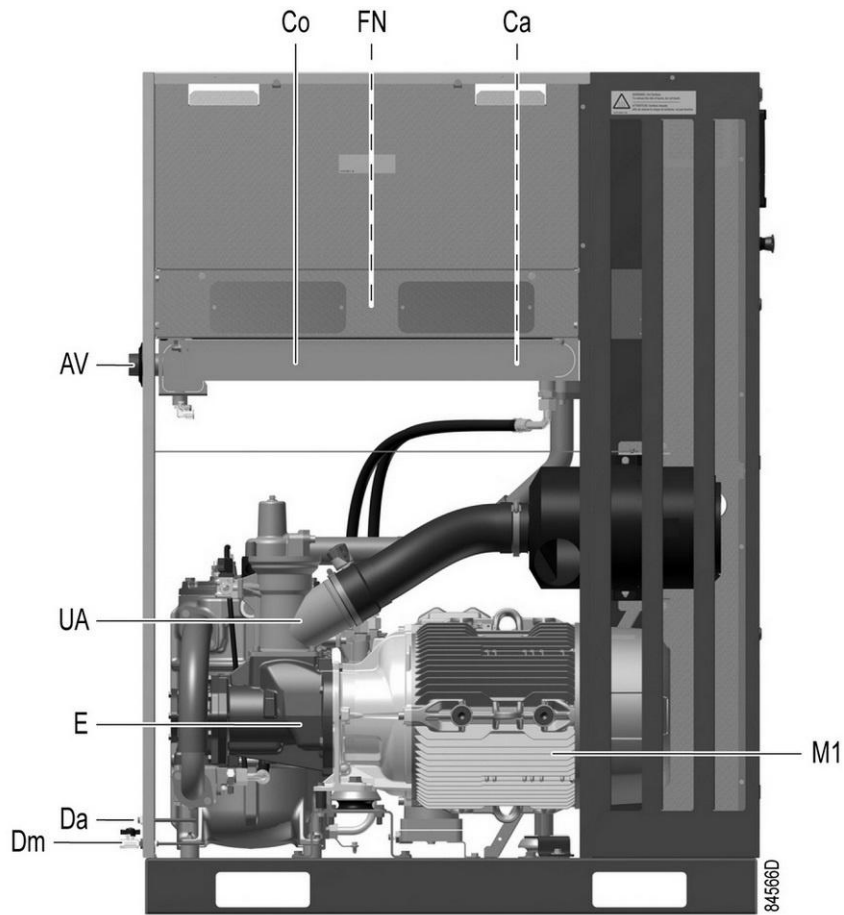

Motor side view, GA 30+ up to GA 45 Pack

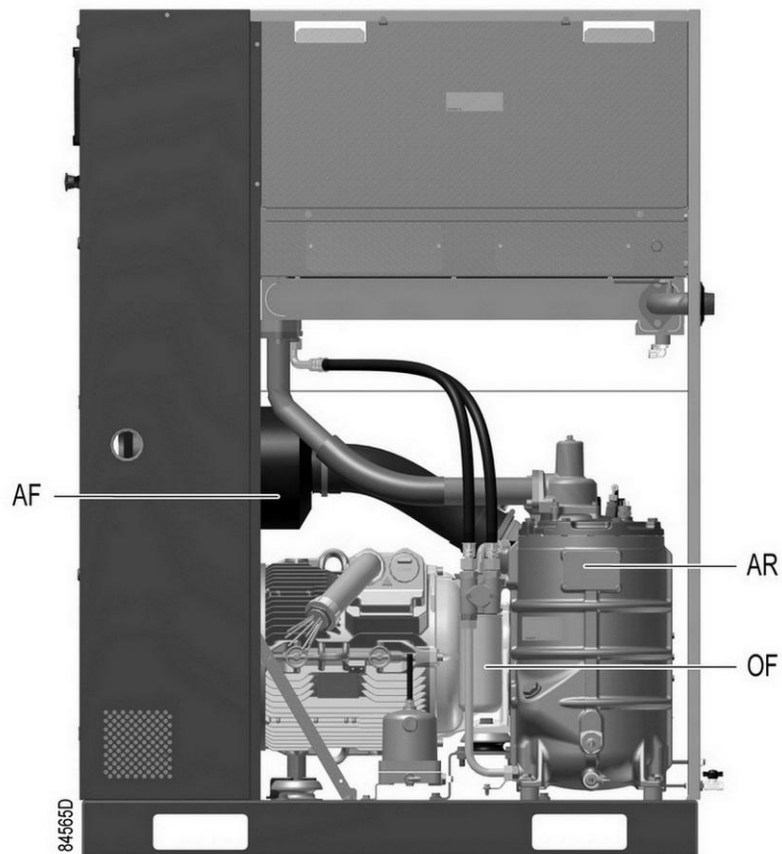

*Service side view, GA 30+ up to GA 45 Pack*

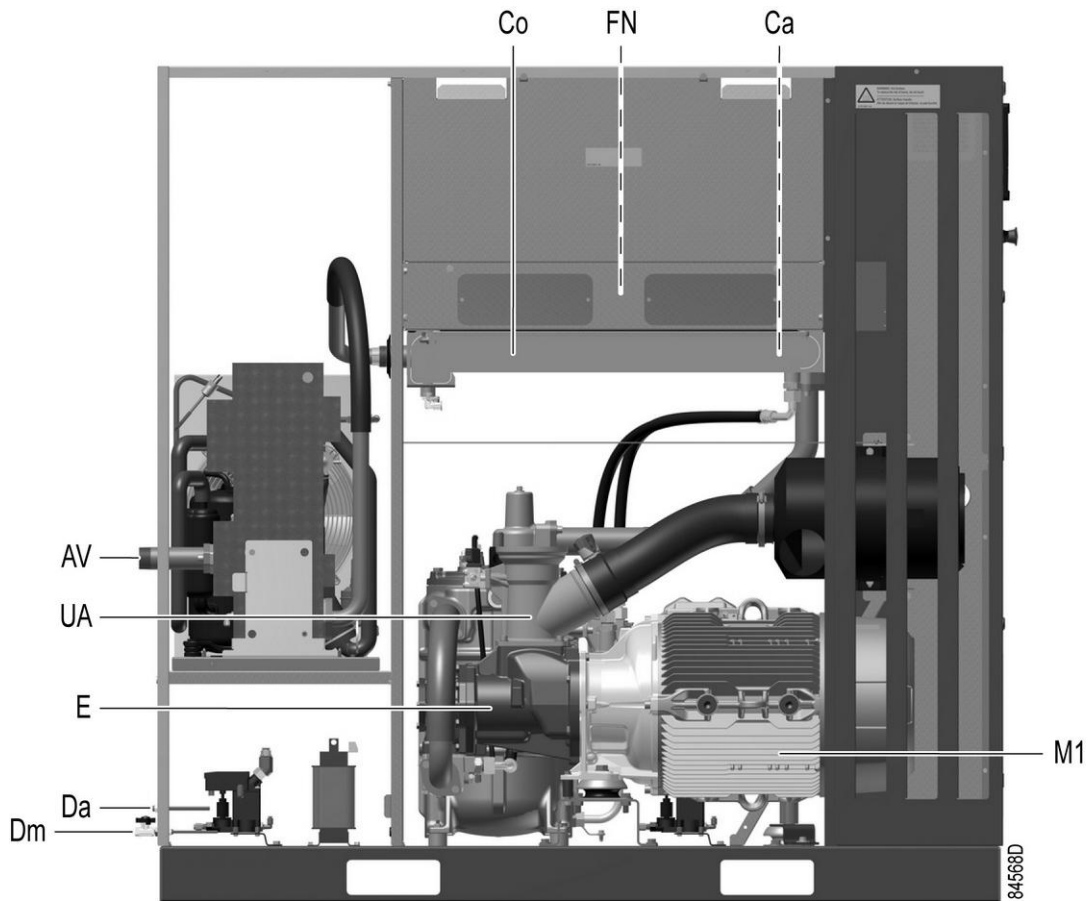

Motor side view, GA 30+ up to GA 45 Full-Feature

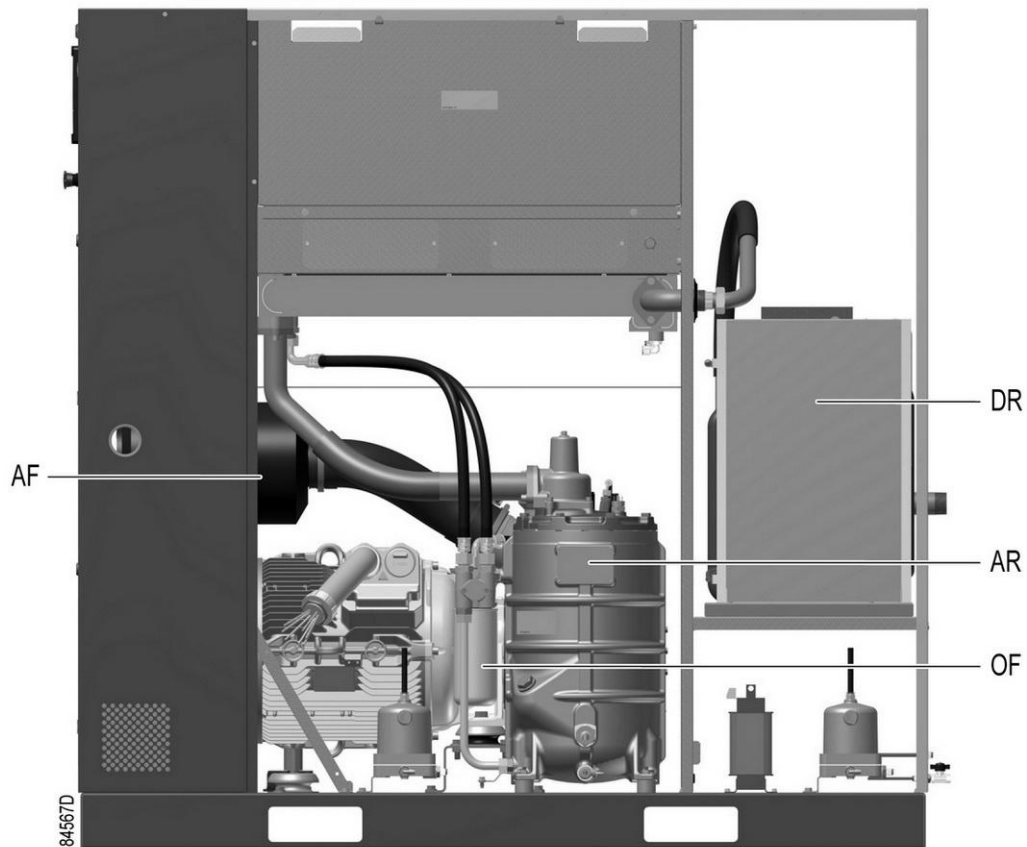

Service side view, GA 30<sup>+</sup> up to GA 45 Full-Feature

References

1	Electric cabinet
AV	Outlet valve
Ca	Air cooler
Co	Oil cooler
E	Compressor element
ER	Elektronikon™ controller
FN	Cooling fan
M1	Motor of the compressor
S3	Emergency stop button
UA	Unloader
Da (Dm)	Condensate outlets
AF	Air filter
AR	Air receiver (oil separator tank)
OF	Oil filter
DR	Dryer (only on units with integrated dryer)

## 2.2 Air and oil circuit

### Air circuit

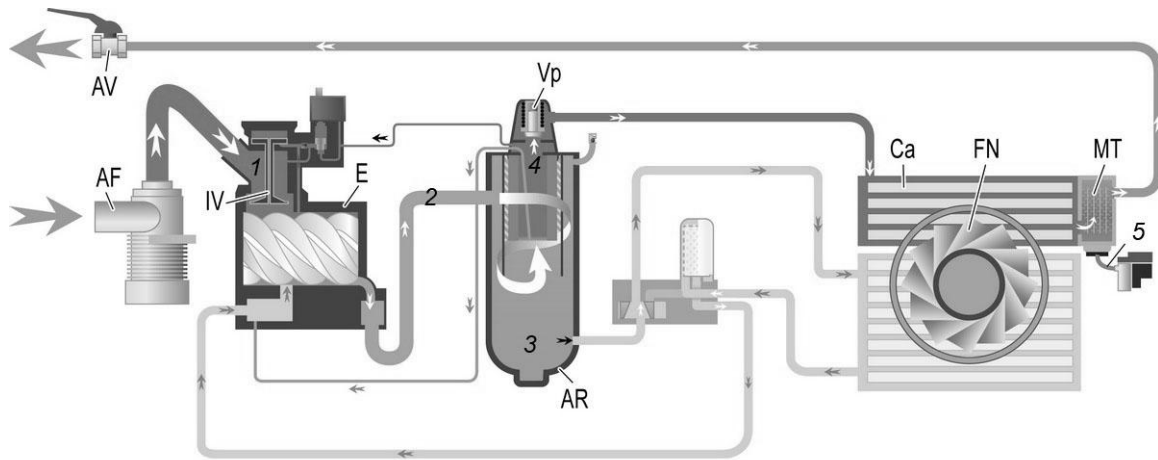

- |   |                   |   |                      |
|---|-------------------|---|----------------------|
| 1 | ■ Intake air      | 4 | ■ Wet compressed air |
| 2 | ■ Air/oil mixture | 5 | ■ Condensate         |
| 3 | ■ Oil             |   |                      |

84546D

*Flow diagram, air circuit (compressors without integrated dryer)*

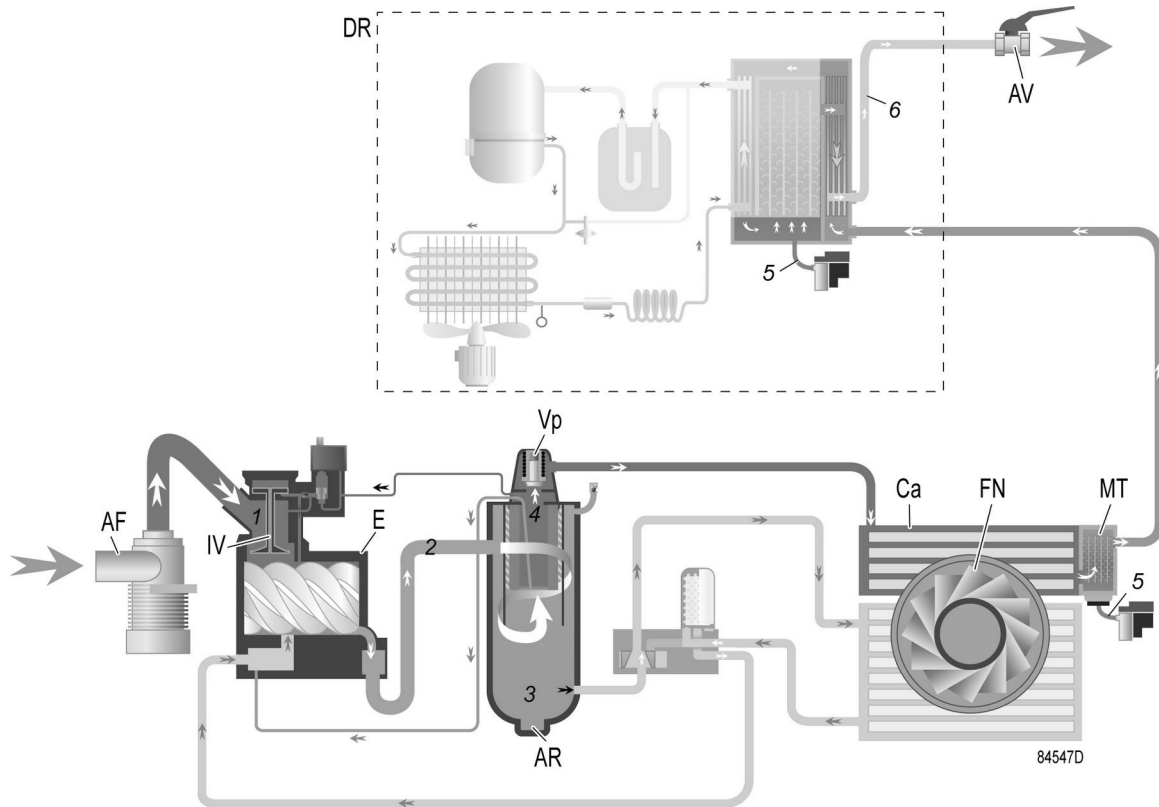

- 1 ■ Intake air
- 2 ■ Air/oil mixture
- 3 ■ Oil
- 4 ■ Wet compressed air
- 5 ■ Condensate
- 6 ■ Dried compressed air

Flow diagram, air circuit (compressors with integrated dryer)

Reference	Description
1	Intake air
2	Air/oil mixture
3	Oil
4	Wet compressed air
5	Condensate
6	Dried compressed air

**Description**

Air drawn through inlet filter (AF) and open inlet valve (IV) of the unloader is compressed in compressor element (E). A mixture of compressed air and oil flows into the air receiver/oil separator tank (AR). The air is discharged through outlet valve (AV) via minimum pressure valve (Vp) and air cooler (Ca).

The air cooler is provided with a moisture trap (MT).

On compressors with integrated dryer, the air flows through air dryer (DR) before it is discharged through outlet valve (AV). Also see section [Air dryer](#).

Under all circumstances, the minimum pressure valve (Vp) keeps the pressure in the separator tank (AR) above the minimum value that is required for lubrication of the compressor element. An integrated check valve prevents the compressed air downstream the minimum pressure valve from being vented to atmosphere during unloaded operation. When the compressor is stopped, inlet valve (IV) closes, preventing compressed air (and oil) to be vented into the air filter.

**Oil circuit**

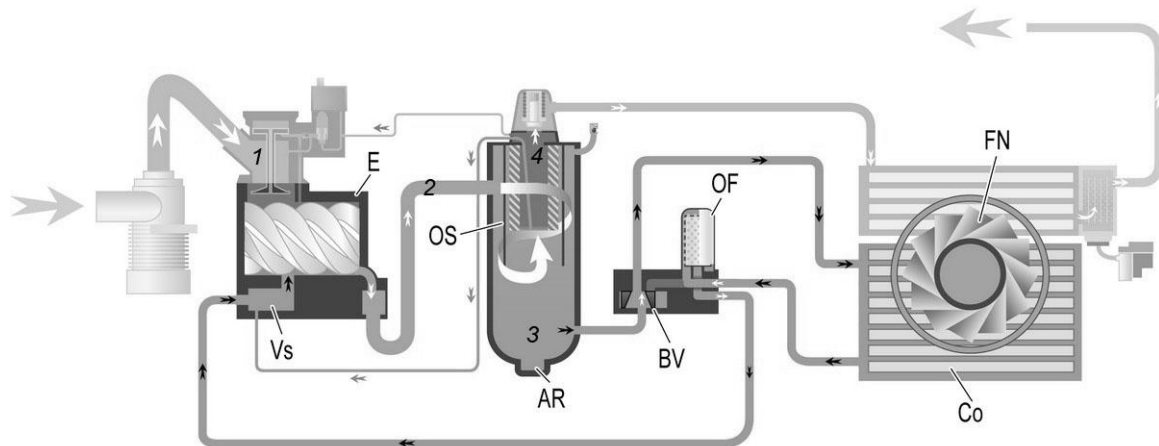

- 1 ■ Intake air
- 2 ■ Air/oil mixture
- 3 ■ Oil
- 4 ■ Wet compressed air

84548D

*Flow diagram, oil circuit*

Reference	Description
1	Intake air
2	Air/oil mixture
3	Oil
4	Wet compressed air

**Description**

Air pressure in the separator tank forces the oil via oil filter (OF) to compressor element (E), where it acts as sealant, coolant, lubricant and corrosion inhibitive (during stand still periods).

In air receiver/oil separator tank (AR), most of the oil is separated from the air/oil mixture by gravity and inertia. The remaining oil is separated by oil separator (OS). The oil collects in the lower part of air receiver/oil separator (AR).

The oil circuit is provided with a thermostatic bypass valve (BV). When the oil temperature is below its setpoint, the oil cooler is bypassed. Bypass valve (BV) starts opening the supply to cooler (Co) when the oil temperature has increased to the setpoint temperature. At approx. 15 °C (27 °F) above the setpoint temperature, all the oil flows through the oil cooler.

A tropical thermostatic valve (available as an option) offers a higher opening temperature, it helps avoiding condensate accumulation in the oil. This option is advised when the compressor operates in high humidity conditions.

## 2.3 Cooling system

### Diagram

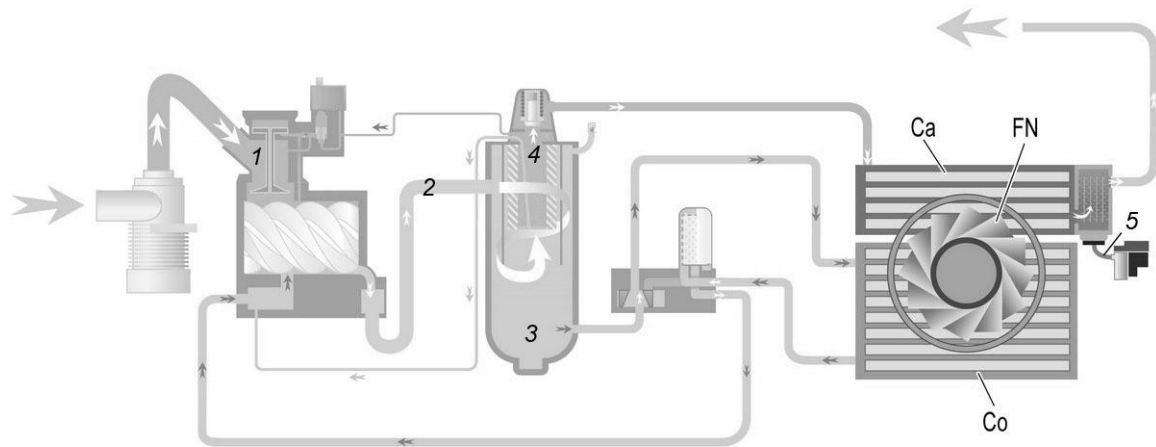

- 1 ■ Intake air
- 2 ■ Air/oil mixture
- 3 ■ Oil
- 4 ■ Wet compressed air
- 5 ■ Condensate

84549D

Reference	Description
1	Intake air
2	Air/oil mixture
3	Oil
4	Wet compressed air
5	Condensate

### Description

The cooling system on air-cooled compressors comprises air cooler (Ca) and oil cooler (Co). The cooling air flow is generated by fan (FN).

## 2.4 Condensate system

The condensate, collected in the moisture trap of the air cooler, is evacuated via an automatic drain. A compressor with integrated dryer has an additional drain on the moisture trap of the dryer. Each drain is connected to its outlet connection (Da) and a manual drain valve (Dm).

### Mechanical drains

GA 37 and GA 45 have a mechanical condensate drain (MWD).

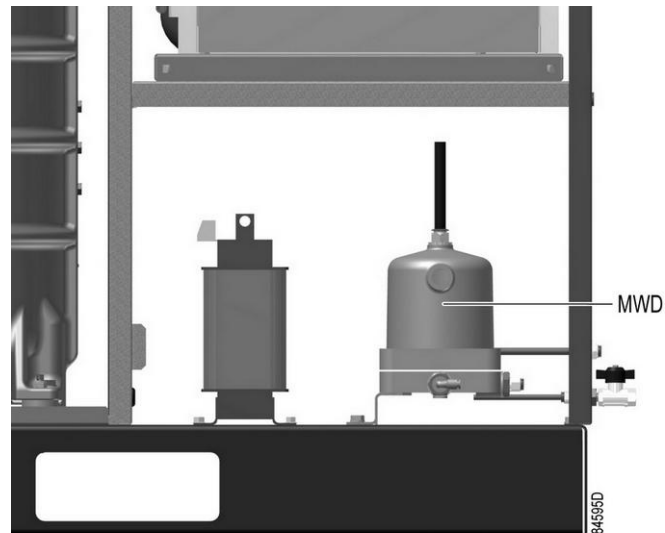

*Mechanical condensate drain*

A float opens or closes the outlet dependant on the level of the condensate in the bowl.

### **Electronic drains**

The GA 30<sup>+</sup> Pack has an electronic water drain (EWD). On Full-Feature GA 30<sup>+</sup> compressors, an additional electronic water drain is provided.

The condensate accumulates in the collector of the drain. When the condensate reaches a certain level, it is discharged through the automatic drain outlet (Da).



The Test button on top of the drain can be used in three different ways, according the situation:

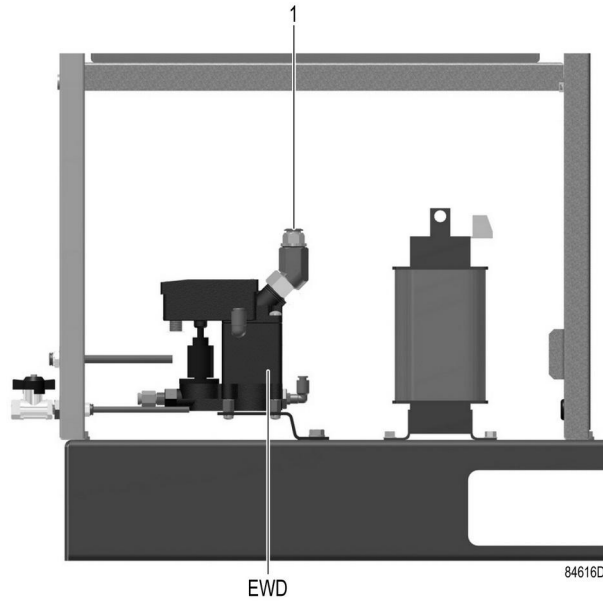

- When pressed during normal operation, it starts the manual drain test.
- When pressed during an alarm, it resets the control logic
- By pressing the Test button for at least 5 seconds, the self diagnosis routine will start.



*Electronic condensate drains*

LED explanation

 <p>84730D</p>	<p><b>Green LED on</b> Normal operation, drain is in standby and awaiting condensate.</p>
 <p>84731D</p>	<p><b>Green LED blinking</b> Normal operation, drain valve is open to drain water.</p>
 <p>84732D</p>	<p><b>Green LED fading on/off</b> Water is not flowing in to the drain's tank. If the floater does not reach the upper level for 3 hours, the solenoid is energized for 2 seconds. This cycle is repeated for 5 times (so up to 15 hours). Afterwards, the green light starts fading on/off.</p> <p>Causes:</p> <ul style="list-style-type: none"> <li>• No condensate entering the tank.</li> <li>• Float mounted incorrectly (upside down).</li> </ul> <p>Checks:</p> <ul style="list-style-type: none"> <li>• Is any condensate reaching the drain? Does the water separation take place in the heat exchanger?</li> <li>• Is the floater mounted in its correct position, for instance after maintenance?</li> </ul> <p>Solution:</p> <ul style="list-style-type: none"> <li>• Although this LED sign does not indicate any kind of failure, the drain can be reset by pushing the test button (T) for 5 seconds.</li> </ul>

 <p>847330</p>	<p><b>Red LED blinking slowly: cleaning routine 1</b></p> <p>The drain's tank is filled and the water cannot be drained or can only be drained very slowly. In normal operation, the drain gets 20 seconds time to drain all water. If the drain is not emptied within this time frame, a (first) cleaning routine is activated, alternatively opening and closing the valve for 2 seconds, during maximum 30 cycles. This routine is started in an attempt to unblock the drain.</p> <p>If this first unlock routine is unsuccessful, a second routine will be started.</p> <p>Causes:</p> <ul style="list-style-type: none"> <li>• Filter mesh clogged.</li> <li>• Not enough pressure on drain.</li> <li>• Internal problem with the drain.</li> </ul> <p>Checks:</p> <ul style="list-style-type: none"> <li>• Is the filter clean and in good condition?</li> <li>• Is there a minimum pressure of 0.2 bar (2.8 psi) in the drain?</li> </ul> <p>Press the test button (T) for at least 5 seconds to reset the drain.</p>
 <p>847340</p>	<p><b>Red LED blinking fast</b></p> <p>If cleaning routine 1 is completed (after 30 cycles) but still unsuccessful, cleaning routine 2 is activated. This routine will open (3 sec) and close (60 sec) the drain's valve until a floater is in lower position, so the water is completely drained.</p> <p>Meanwhile, the <b>external alarm signal is activated</b>.</p> <p>Causes:</p> <ul style="list-style-type: none"> <li>• Filter mesh clogged.</li> <li>• Not enough pressure on drain.</li> <li>• Internal problem with the drain.</li> </ul> <p>Checks:</p> <ul style="list-style-type: none"> <li>• Is the filter clean and in good condition?</li> <li>• Is there a minimum pressure of 0.2 bar (2.8 psi) in the drain?</li> </ul> <p>From this point onwards, the drain will remain in this routine, even after restart. Press the test button (T) for at least 5 seconds to reset the drain.</p>
 <p>847350</p>	<p><b>Red LED on</b></p> <p>An irreversible error occurred. Replace the drain and keep the failed one for further analysis.</p>

**Drain connections**

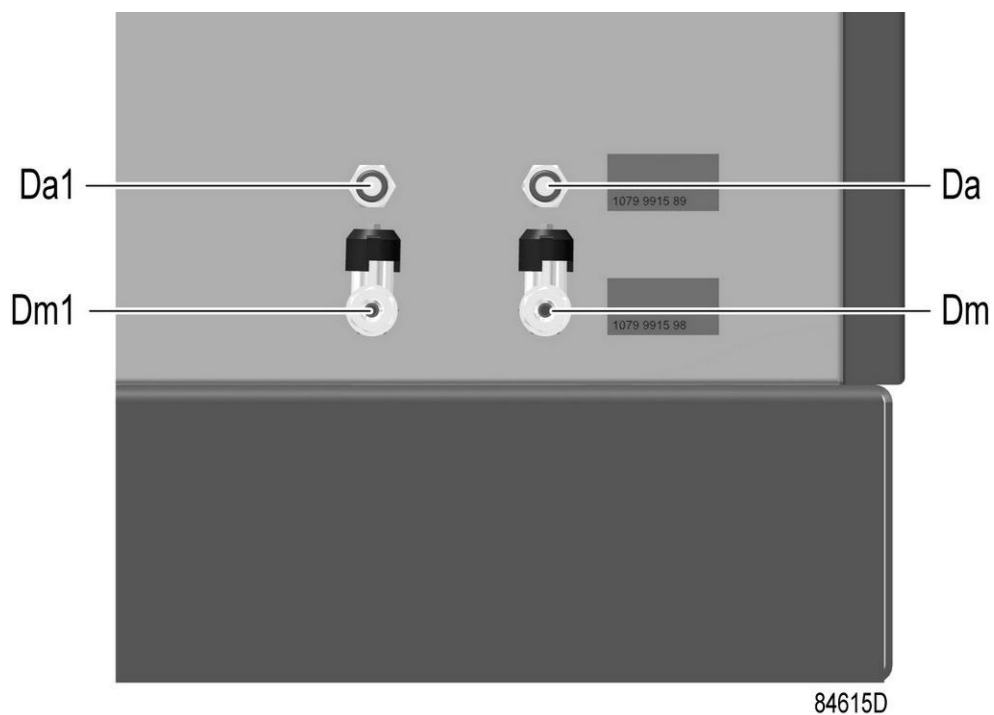

*Condensate drain connections*

Reference	Designation
Da	Automatic drain connection
Dm	Manual drain valve
Da1	Automatic drain connection of the dryer (only on units with integrated dryer)
Dm1	Manual drain valve of the dryer (only on units with integrated dryer)

## 2.5 Regulating system

### Load/unload regulating system

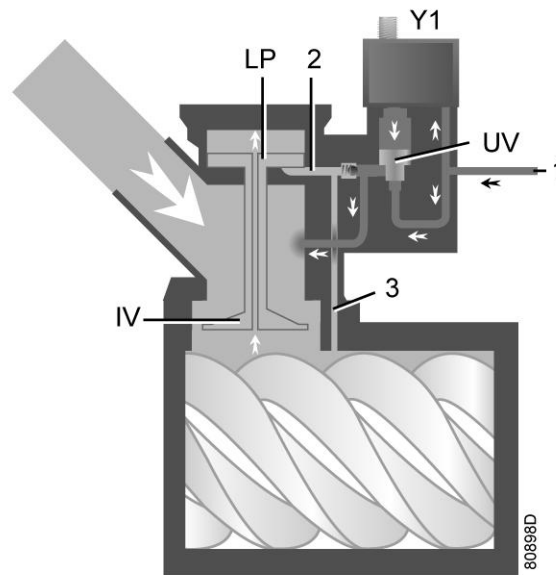

*Regulating system (loaded condition)*

#### Loading

When the net pressure is below the loading pressure, solenoid valve (Y1) is energised. Results:

- The space above unloading valve/blow-off valve (UV) is connected with the oil separator tank pressure (1) via the solenoid valve.
- Unloading valve/blow-off valve (UV) moves downwards, closing off the connection to channels (2) and (3).
- Underpressure from the compressor element causes loading plunger (LP) to move downwards and inlet valve (IV) to open fully.

Air delivery is 100%, the compressor runs loaded.

#### Unloading

If the air consumption is less than the air output of the compressor, the net pressure increases. When the net pressure reaches the unloading pressure, solenoid valve (Y1) is de-energised.

Results:

- The pressure above unloading valve/blow-off valve (UV) is released to atmosphere and the space above valve (UV) is no longer in connection with the oil separator tank pressure (1).
- Unloading valve/blow-off valve (UV) moves upwards, connecting the oil separator tank pressure (1) with channels (2) and (3).
- The pressure in channel (2) causes the loading plunger (LP) to move upwards, causing inlet valve (IV) to close, while the pressure is gradually released to atmosphere.
- The pressure in the separator tank stabilises at low value. A small amount of air is kept drawn in to guarantee a minimal pressure, required for lubrication during unloaded operation.

Air output is stopped, the compressor runs unloaded.

## 2.6 Electrical system

### Electrical components

The electrical system comprises following components:

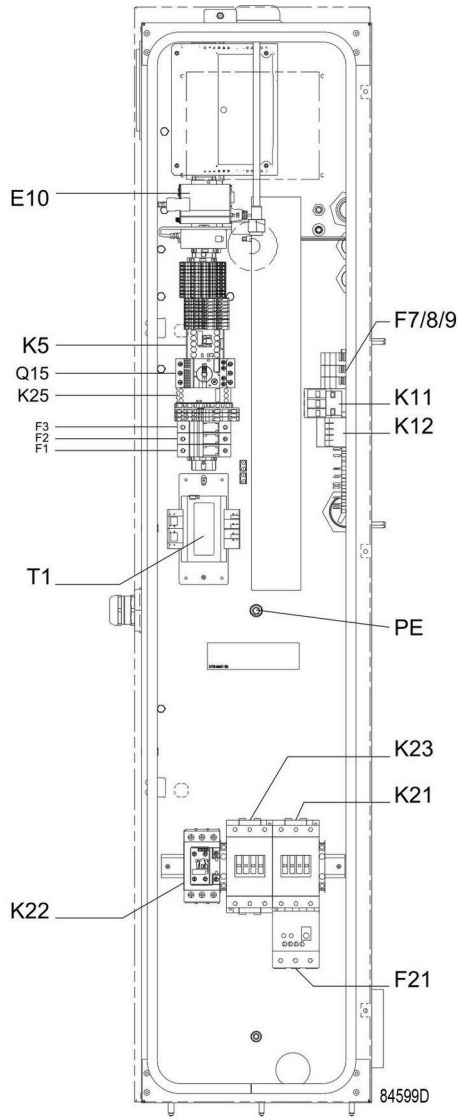

*Typical example of electric cubicle*

Reference	Designation
F1	Fuse
F2	Fuse
F3	Fuse
F7/8/9	Fuses (only on units with integrated dryer)
F21	Overload relay, compressor motor

Reference	Designation
Q15	Circuit breaker, fan motor (on air-cooled compressors)
K5	Auxiliary relay
K11	Auxiliary contactor (only on units with integrated dryer)
K12	Auxiliary contactor (only on units with integrated dryer)
K25	Phase sequence relay
E10	Smartbox
K21	Line contactor
K22	Star contactor
K23	Delta contactor
T1	Transformer
PE	Earth terminal

**Electrical diagram**

9828 5102 00	Service diagram
--------------	-----------------

The complete electrical diagram can be found in the electric cubicle and on the CD-ROM, supplied with the machine.

**2.7 Air dryer**

(On compressors with integrated dryer only)

**Flow diagram**

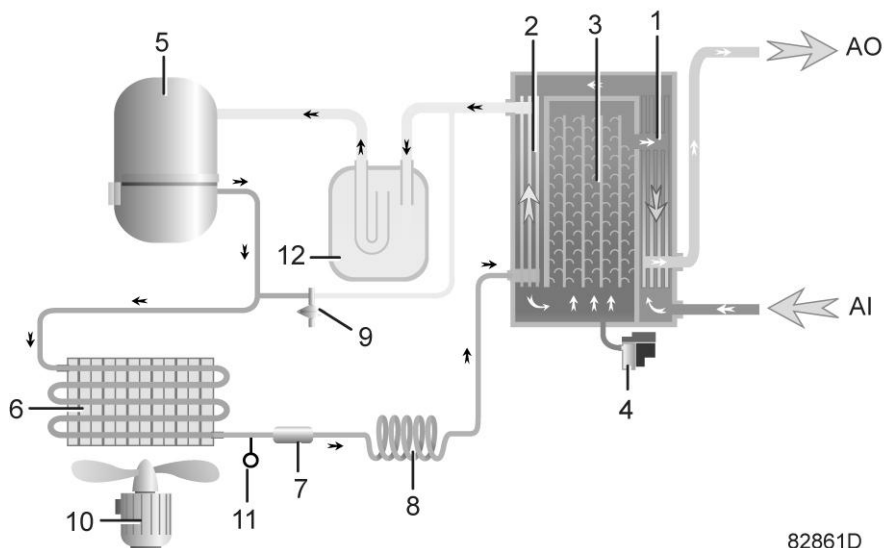

82861D

*Air dryer*

Reference	Name
AI	Air inlet
AO	Air outlet
1	Air/air heat exchanger
2	Air/refrigerant heat exchanger/evaporator
3	Condensate separator
4	Automatic drain / condensate outlet
5	Refrigerant compressor
6	Refrigerant condenser
7	Liquid refrigerant dryer/filter
8	Capillary
9	Bypass valve
10	Condenser cooling fan
11	Pressure switch, fan control
12	Liquid separator

### Compressed air circuit

Compressed air enters heat exchanger (1) and is cooled by the outgoing, cold, dried air. Water in the incoming air starts to condense. The air then flows through heat exchanger/evaporator (2), where the refrigerant evaporates, causing the air to be cooled further to close to the evaporating temperature of the refrigerant. More water in the air condenses. The cold air then flows through separator (3) where all the condensate is separated from the air. The condensate is automatically drained through condensate drain (4).

The cold, dried air flows through heat exchanger (1) where it is warmed up by the incoming air.

### Refrigerant circuit

Compressor (5) delivers hot, high-pressure refrigerant gas which flows through condenser (6) where most of the refrigerant condenses.

The liquid refrigerant flows through liquid refrigerant dryer/filter (7) to capillary tube (8). The refrigerant leaves the capillary tube at about evaporating pressure.

The refrigerant enters evaporator (2) where it withdraws heat from the compressed air by further evaporation at about constant pressure. The heated refrigerant leaves the evaporator and is sucked in by the compressor (5) through a liquid separator (12).

Bypass valve (9) regulates the refrigerant flow. Fan (10) is switched on or off by switch (11) depending on the pressure degree of the condensate.

## 3 Elektronikon™ controller

### 3.1 Elektronikon™ controller

#### Control panel



#### Introduction

The Elektronikon™ controller has following functions:

- Controlling the compressor
- Protecting the compressor
- Monitoring components subject to service
- Automatic restart after voltage failure (made inactive)

#### Automatic control of the compressor

The controller maintains the net pressure between programmable limits by automatically loading and unloading the compressor. A number of programmable settings, e.g. the unloading and loading pressures, the minimum stop time and the maximum number of motor starts within a given period of time are taken into account.

The controller stops the compressor whenever possible to reduce the power consumption and restarts it automatically when the net pressure decreases. If the expected unloading period is too short, the compressor is kept running to prevent too short stand-still periods.

#### Protecting the compressor

Several sensors are provided on the compressor. If one of the measured signals exceeds the programmed shutdown level, the compressor will be stopped or a warning is given.

##### Shutdown

Example: If the compressor element outlet temperature exceeds the programmed shutdown level, the compressor will be stopped. This will be indicated on the display of the controller. The compressor will also be stopped in case of overload of the drive motor or overload of the fan motor.



Before remedying, consult the [Safety precautions](#).

### Shutdown warning

A shutdown warning level is a programmable level below the shutdown level.

If one of the measurements exceeds the programmed shutdown warning level, this will also be indicated to warn the operator before the shutdown level is reached.

### Service warning

If the service timer exceeds a programmed value, this will be indicated on the display to warn the operator to carry out some service actions.

### Other warnings

On compressors equipped with an integrated dryer, a warning message will appear if the dew point is too high or too low for the given ambient temperature.

### Automatic restart after voltage failure

The controller has a built-in function to automatically restart the compressor when the voltage is restored after voltage failure. For compressors leaving the factory, this function is made inactive. If desired, the function can be activated. The ARAVF label 1079 9932 74 (see section Pictographs) shall be glued near to the controller. Consult your local supplier.

	<p>If activated, and if the controller was in the automatic operation mode, the compressor will automatically restart when the supply voltage to the module is restored!</p>
--	--

## 3.2 Control panel

### Detailed description

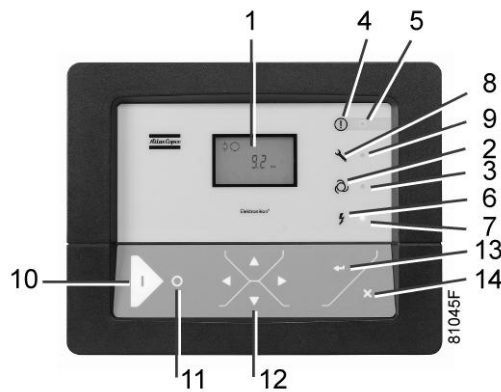













Control panel of the Elektronikon controller





Reference	Designation	Function
1	Display	Shows icons and operating conditions.
2	Automatic operation symbol	

Reference	Designation	Function
3	LED, Automatic operation	Indicates that the regulator is automatically controlling the compressor: the compressor is loaded, unloaded, stopped and restarted depending on the air consumption and the limitations programmed in the regulator.
4	Warning symbol	
5	LED, Warning	Is lit if a warning condition exists.
6	Voltage symbol	
7	LED, Voltage on	Indicates that the voltage is switched on.
8	Service symbol	
9	LED, Service	Is lit when service is needed.
10	Start button	This button starts the compressor. Automatic operation LED (3) lights up. The Elektronikon is operative.
11	Stop button	This button is used to stop the compressor. Automatic operation LED (3) goes out.
12	Scroll buttons	Use these buttons to scroll through the menu.
13	Enter button	Use this button to confirm the last action.
14	Escape button	Use this button to go to previous screen or to end the current action.

### 3.3 Icons used on the display

Function	Icon	Description
Compressor status	 81532D	When the compressor is stopped, the icon stands still. When the compressor is running, the icon is rotating.
	 81533D	Motor stopped
	 81534D	Running unloaded
	 81535D	Running loaded
Machine control mode	 81536D	Remote start / stop
	 81537D	LAN control

Function	Icon	Description
Automatic restart after voltage failure	 81538D	Automatic restart after voltage failure is active
Timer	 81539D	
Active protection functions	 81540D	Emergency stop
Service	 81541D	Service required
Units	<b>MPa</b> 81116D	Pressure unit (Mega Pascal)
	<b>psi</b> 81115D	Pressure unit (pounds per square inch)
	<b>bar</b> 81114D	Pressure unit (bar)
	<b>°C</b> 81108D	Temperature unit (degree Centigrade)
	<b>°F</b> 81107D	Temperature unit (degree Fahrenheit)
	<b>hrs</b> 81109D	Hours (always shown together with seconds)
	<b>%</b> 81113D	Percent
	<b>x10</b> 81112D	The value shown must be multiplied by 10 to get the actual value
	<b>x100</b> 81111D	The value shown must be multiplied by 100 to get the actual value
	<b>x1000</b> 81110D	The value shown must be multiplied by 1000 to get the actual value
	 81542D	Motor (overload)
	 81543D	Element outlet temperature.

Function	Icon	Description
	 81544D	Filter
	 81545D	Drain
	 81104D	Energy saving (dryer)
	 81117D	Ambient temperature
	 81106D	Dewpoint temperature

	This chapter gives a general survey of available icons. Not all icons mentioned in this chapter are available on every machine.
--	---

### 3.4 Main screen

When the voltage is switched on, the first screen is a test screen. The next screen is the Main screen, shown automatically.



The Main screen shows:

- The compressor status by means of pictographs
- The air outlet pressure

	Always consult Atlas Copco if the pressure on the display is preceded by a "t".
---	---

### 3.5 Shut-down warning

#### Description

A shut-down warning will appear in the event of:

- Too high a temperature at the outlet of the compressor element
- Too fast increase of temperature at the outlet of the compressor element
- Too high a dewpoint temperature (Full-Feature compressors)

#### Compressor element outlet temperature

- If the outlet temperature of the compressor element exceeds the shut-down warning level (see section Programmable settings), warning LED (5) starts blinking.

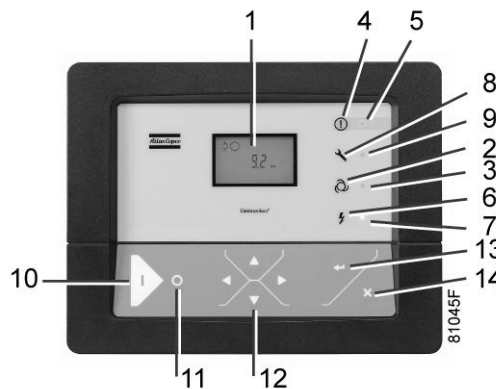

- Press Scroll down button (12). The screen shows the temperature at the compressor element outlet:



It remains possible to scroll through other screens, using the Scroll buttons up and down (12) to check the actual status of other parameters. Press button (11) to stop the compressor and wait until the compressor has stopped. Switch off the voltage, inspect the compressor and remedy. The warning message will disappear as soon if the warning condition disappears.

#### Dewpoint temperature

On compressors with integrated dryer, alarm LED (5) will light up and the related pictograph will appear flashing if the dewpoint temperature exceeds the warning level (programmable).



*Main screen with the dewpoint temperature warning*

The related pictograph



will appear flashing

Press the Scroll button (12) until the actual dewpoint temperature appears.

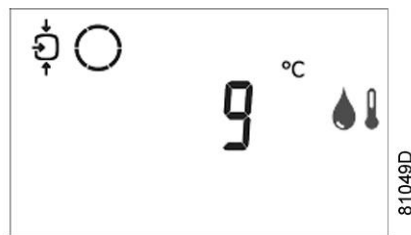

*Warning screen, dewpoint temperature*

The screen shows that the dewpoint temperature is 9°C.

- It remains possible to scroll through other screens (using Scroll buttons 12) to check the actual status of other parameters.
- Press button (11) to stop the compressor and wait until the compressor has stopped.
- Switch off the voltage, inspect the compressor and remedy.
- The warning message will disappear as soon as the warning condition disappears.

## 3.6 Shut-down

### Description

#### The compressor will be shut down:

- In case the temperature at the outlet of the compressor element exceeds the shut-down level
- In case of error of the outlet pressure sensor
- In case of overload of the drive motor
- In case of overload of the fan motor on air-cooled compressors

### Compressor element outlet temperature

- If the outlet temperature of the compressor element exceeds the shut-down level (factory setting 120 °C / 248 °F, programmable) the compressor will be shut-down, alarm LED (5) will flash, automatic operation LED (3) will go out and the following screen will appear:



Main screen with shut-down indication, element outlet temperature

The related pictograph



will appear flashing.

- Press Scroll buttons (12) until the actual compressor element temperature appears.



Shut-down screen, element outlet temperature

The screen shows that the temperature at the outlet of the compressor element is 120 °C.

- Switch off the voltage and remedy the trouble.
- After remedying and when the shut-down condition has disappeared, switch on the voltage and restart the compressor.

### Motor overload

- In the event of motor overload, the compressor will be shut-down, alarm LED (5) will flash, automatic operation LED (3) will go out and the following screen will appear:



Main screen with shut-down indication, motor overload

- Switch off the voltage and remedy the trouble.
- After remedying and when the shut-down condition has disappeared, switch on the voltage and restart the compressor.

### 3.7 Service warning

#### Description

A service warning will appear when the service timer has reached the programmed time interval.

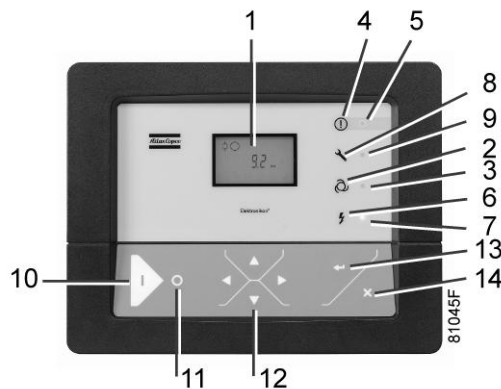

If the service timer exceeds the programmed time interval, service LED (9) will light up.

To display the service timer, press Scroll buttons (12) to scroll to <d.6>: the service symbol is shown. Next, press the Enter button (13). The reading of the service timer is shown in <hrs> (or <x1000 hrs> if the service timer value is higher than 9999).



Example of the service timer screen

The example screen shows that the service timer is at 4002 hours.

Actions to be taken:

Stop the compressor, switch off the voltage and carry out the required service actions. See section Preventive Maintenance.

	<ul style="list-style-type: none"> <li>• The longer interval service actions must also include the shorter interval actions. In the example above, carry out all service operations belonging to the 8000 running hours interval as well as those belonging to the 4000 running hours interval.</li> <li>• The setting of the service timer can be changed in function of the operating conditions. See section Preventive Maintenance schedule.</li> </ul>
--	---

After servicing, reset the service timer. See section [Calling up/resetting the service timer](#)

### 3.8 Scrolling through all screens

#### Control panel

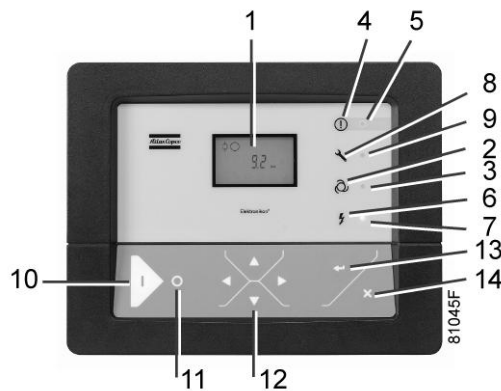

Control panel

Scroll buttons (12) can be used to scroll through all screens. The screens are divided into register screens, measured data screens, digital input screens (numbered as <d. in>, <d. 1>, ...), parameter screens (numbered as <P. 1>, <P. 2>, ...), protections screens (numbered as <Pr. 1>, ...) and test screens (numbered as <t. 1>, ...).

During scrolling, the numbers of the screens appear consecutively. For most screens, the unit of measurement and the related pictograph are shown together with the screen number.

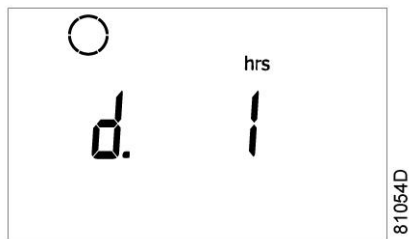

Example

The screen shows the screen number <d.1>, the unit used <hrs> and the related symbol for running hours. Press Enter key (13) to call up the actual running hours.

**Overview of the screens**

<b>Digital input screens</b>	<b>Designation</b>	<b>Related topic</b>
<d. in>	Digital input status	
<d. 1>	Running hours (hrs or x 1000 hrs)	See section <a href="#">Calling-up running hours</a>
<d. 2>	Motor starts (x 1 or x 1000)	See section <a href="#">Calling up motor starts</a>
<d. 3>	Module hours (hrs or x 1000 hrs)	See section <a href="#">Calling up module hours</a>
<d. 4>	Loading hours (hrs or x 1000 hrs)	See section <a href="#">Calling up loading hours</a>
<d. 5>	Load relay (x 1 or x 1000)	See section <a href="#">Calling up load relay</a>
<d. 6>	Service timer reading (hrs or x 1000 hrs)	See section <a href="#">Calling up/resetting the service timer</a>
<d. 7>	Actual program version	

<b>Parameter screens</b>	<b>Designation</b>	<b>Related topic</b>
<P. 1>	Selection between local, remote or LAN control	See section <a href="#">Selection between Local Remote and LAN control</a>
<P. 2>	Setting a node ID for LAN control and the channels for Mk 4 and Mk 5	See section <a href="#">Calling up/modifying CAN address control</a>
<P. 3>	Settings for IP, gateway and Subnet mask	See section <a href="#">Calling up/modifying IP, Gateway and Subnetmask</a>
<P. 4>	Pressure band settings	See section <a href="#">Calling up/modifying pressure band settings</a>
<P. 5>	Setting a pressure band selection	See section <a href="#">Modifying pressure band selection</a>
<P. 6>	Modifying a service timer	See section <a href="#">Calling up/modifying service timer settings</a>
<P. 7>	Setting of unit for temperature	See section <a href="#">Calling up/modifying unit of temperature</a>
<P. 8>	Setting of unit for pressure	See section <a href="#">Calling up/modifying unit of pressure</a>
<P. 9>	Selection for function: Automatic restart after voltage failure (active or not, only for Atlas Copco)	See section <a href="#">Activating automatic restart</a>
<P. 10>	Selection between Y-D or DOL starting	See section <a href="#">Selection between Y-D or DOL starting</a>
<P. 11>	Setting of load delay time	See section <a href="#">Calling up/modifying load delay time</a>
<P. 12>	Setting of minimum stop time	See section <a href="#">Calling up/Modifying minimum stop time</a>
<P. 13>	Setting a password	See section <a href="#">Activating password protection</a>
<P. 14>	Remote pressure sensing	See section <a href="#">Activate Load/Unload remote sensing</a>

<b>Protections screens</b>	<b>Designation</b>	<b>Related topic</b>
<Pr. 1> <Pr. 2> <Pr. 3>	Protections screens	See section <a href="#">Calling up/modifying protection settings</a>

<b>Test screens</b>	<b>Designation</b>	<b>Related topic</b>
<t. 1>	Display test	See sections <a href="#">Test screens</a>
<t. 2>	Safety valve test	See sections <a href="#">Test screens</a>
<t. 3>	Production test	See sections <a href="#">Test screens</a>

Menu flow

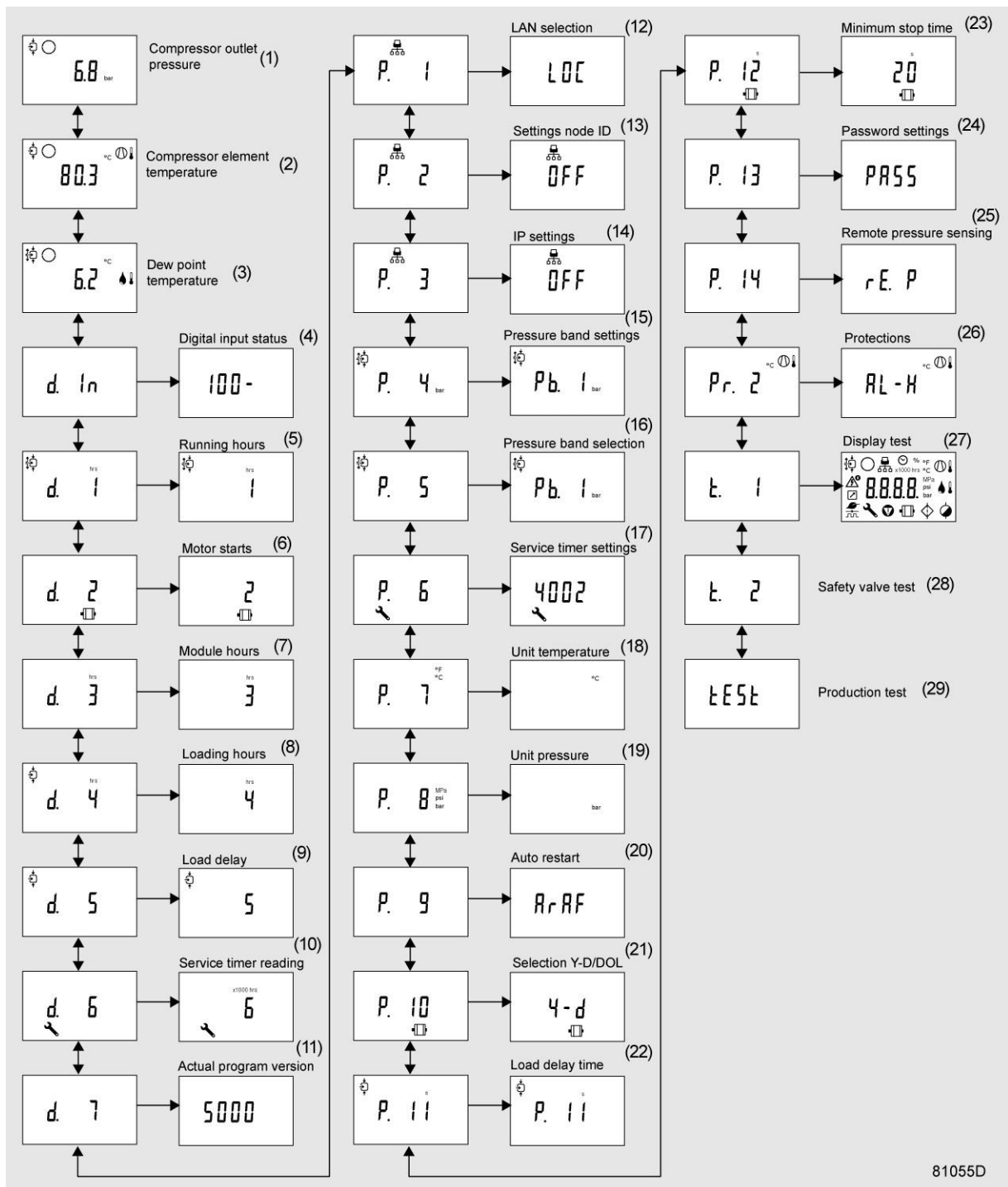

Simplified menu flow

Ref.	Description	Ref.	Description
(1)	Compressor outlet pressure	(16)	Pressure band selection
(2)	Compressor outlet temperature	(17)	Service timer settings
(3)	Dewpoint temperature	(18)	Temperature unit
(4)	Digital input status	(19)	Unit pressure

Ref.	Description	Ref.	Description
(5)	Running hours	(20)	Auto restart
(6)	Motor starts	(21)	Selection Y-D/DOL
(7)	Module hours	(22)	Load delay time
(8)	Loading hours	(23)	Minimum stop time
(9)	Load relay	(24)	Password settings
(10)	Service timer reading	(25)	Remote pressure sensing
(11)	Actual program version	(26)	Protections
(12)	LAN selection	(27)	Display test
(13)	Settings node ID	(28)	Safety valve test
(14)	IP settings	(29)	Production test
(15)	Pressure band settings		

### 3.9 Calling up temperatures

#### Control panel

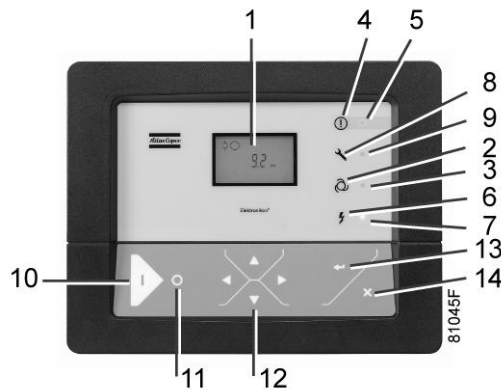

Starting from the Main screen:



- Press Scroll button (12). The outlet temperature will be shown:

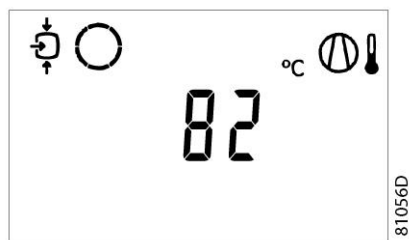

The screen shows that the outlet temperature is 82 °C.

- For Full-Feature compressors:  
Press Scroll button (12). The dew point temperature will be shown:

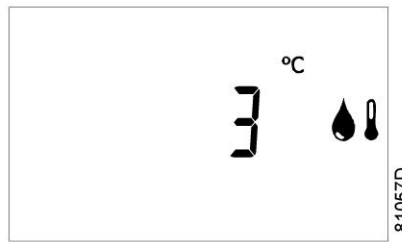

The screen shows that the dew point temperature is 3 °C.

### 3.10 Calling up running hours

#### Control panel

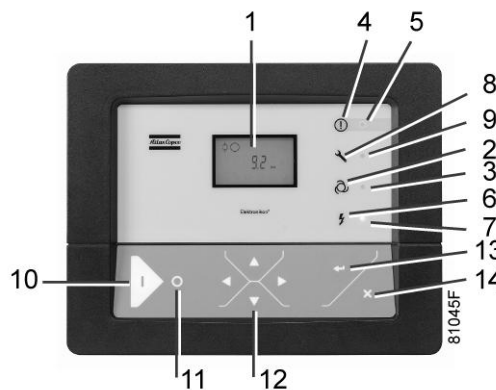

Starting from the Main screen:

- Press Scroll button (12) until <d.1> is shown and then press Enter button (13):



The screen shows the unit used (x1000 hrs) and the value (11.25): the running hours of the compressor are 11250 hours.

### 3.11 Calling up motor starts

#### Control panel

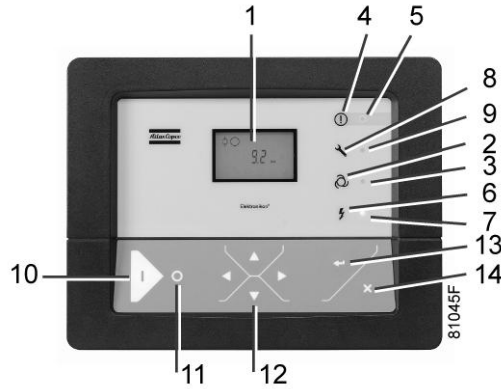

Starting from the Main screen, press Scroll button (12) until <d. 2> is shown and then press Enter button (13). A screen similar to the following appears:

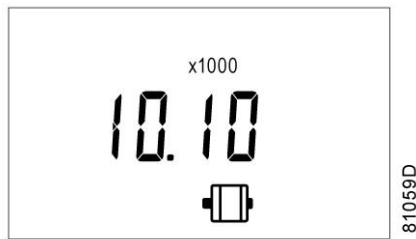

This screen shows the number of motor starts (x 1 or - if <x1000> lights up - x 1000). In the above example, the number of motor starts is 10100.

### 3.12 Calling up module hours

#### Control panel

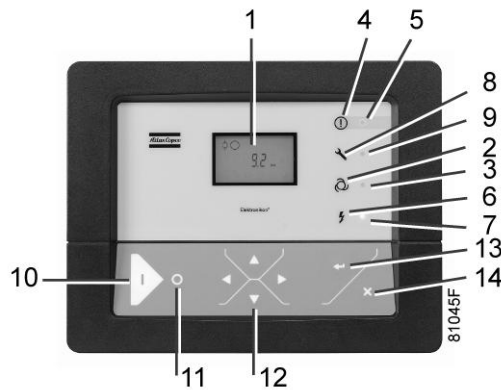

Starting from the Main screen, press Scroll button (12) until <d. 3> is shown and then press Enter button (13). A screen similar to the following appears:



In the example shown, the screen shows the unit used (hrs) and the value (5000): the regulator module has been in service during 5000 hours.

### 3.13 Calling up loading hours

Starting from the Main screen:

- Press Scroll button (12) until <d.4> is shown and then press Enter button (13):



The screen shows the unit used <hrs> (or <x1000 hrs>) and the value <1755>: the compressor has been running loaded during 1755 hours.

### 3.14 Calling up load relay

Starting from the Main screen:



- Press Scroll button (12) until <d.5> is shown and then press Enter button (13):

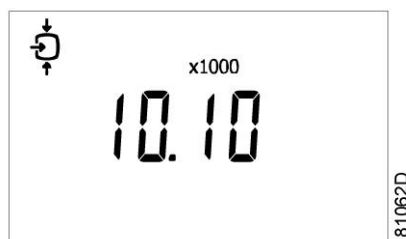

This screen shows the number of unload to load actions (x 1 or - if <x1000> lights up - x 1000). In the above example, the number of unload to load actions is 10100.

### 3.15 Calling up/resetting the service timer

#### Calling up the service timer

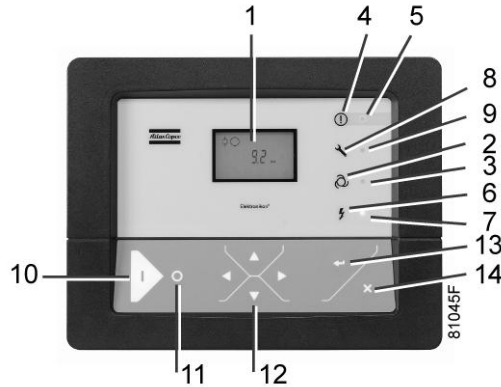

Starting from the Main screen:



- Press Scroll button (12) until <d.6> is shown and then press Enter button (13):



This screen shows the unit used <hrs> (or <x1000 hrs>) and the value <1191>. In the example shown, the compressor has run 1191 hours since the previous service.

#### Resetting the service timer

After servicing, see section [Service warning](#), the timer has to be reset:

- Scroll to register screen <d.6> and press Enter button (13).
- The reading (e.g. 4000) will appear.
- Press Enter button (13) and - if a password is set - enter the password. The icon will flash (indicating that resetting is possible).
- Press Enter button (13) to reset the timer to <0.000> or press the Escape button (14) to cancel the operation.

### 3.16 Selection between local, remote or LAN control

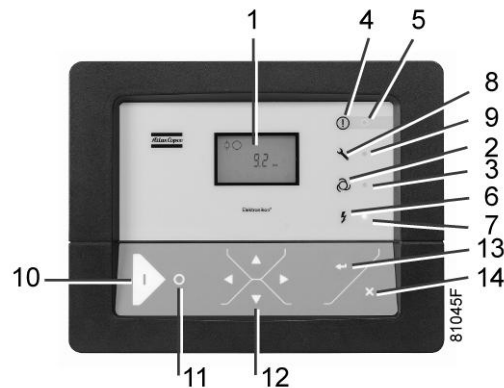

Starting from the Main screen, press Scroll button (12) until <P. 1> is shown and then press Enter button (13). The actually selected control mode is shown: <LOC> for local control, <rE> for remote control or <LAN> for LAN control.

To change: press Enter button (13) and - if necessary - enter the password (see section [Activating password protection](#)). The actually selected control mode is blinking. Use Scroll button (12) to change the control mode. Press Enter button (13) to program the new control mode or press Escape button (14) to cancel.

### 3.17 Calling up/modifying CAN address

#### Calling up

Starting from the main screen, press the Scroll button (12) until <P. 2> is shown and then press Enter button (13).

If necessary enter the password. The next screen shows that the function is ON or OFF. Press the Enter button (13) to change this mode. Use the Scroll buttons (12) to select <On> or <OFF> and press Enter to program.

When this function is ON, use the Scroll buttons up or down (12) to see the node ID.

If desired the user can change this ID. Press the Enter button (13): the node ID value starts blinking. Use the Scroll buttons (12) to change the node ID. Press the Enter button (13) to program the new node ID or press the Escape button (14) to leave this screen or to cancel this operation.

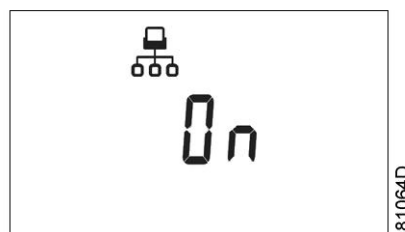

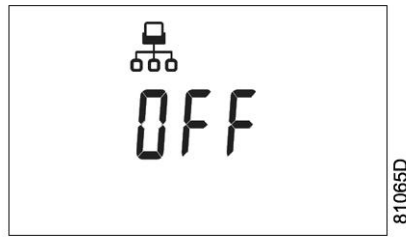

**Modifying the node ID**

The node ID can be changed; use a value between 1 and 31. When the function is ON, the parameters cannot be modified. Change the function to OFF to change the node ID.

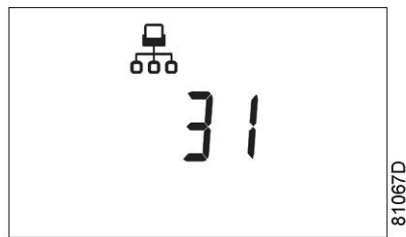
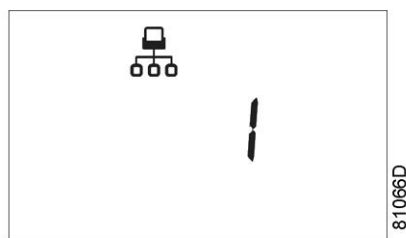

It is also possible to change the channels. The controller has 4 channels. When changing the channels, the controller can act as a Mk IV controller (a previous version of the controller). To set the channels, go to the screen where the node ID is visible. Press the Scroll button down (12). The following screen appears:

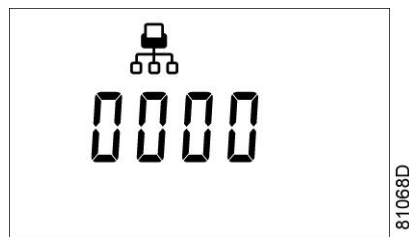

Press the Enter button (13) to modify the setting. The utmost left value will blink. Change this value by using the Scroll buttons (12). Press the Enter button (13) to confirm. Change the other values in the same way, as required.

After modifying the settings, the screen may look as follows:



## 3.18 Calling up/modifying IP, Gateway and Subnetmask

### Calling up

Starting from the Main screen, press the Scroll button (12) until <P. 3> is shown and then press Enter button (13).

The next screen shows either <OFF> or <On>. If <On>, press the Enter button (13) to modify it to <OFF>. Use the Scroll buttons Up or Down (12) to scroll between the items in this list (<IP> for IP address, <Sub> for Subnetmask or <GATe> for Gateway):

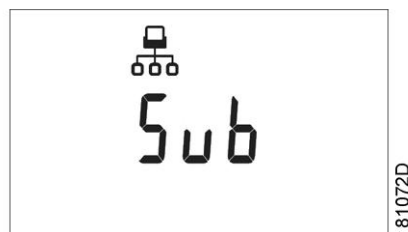
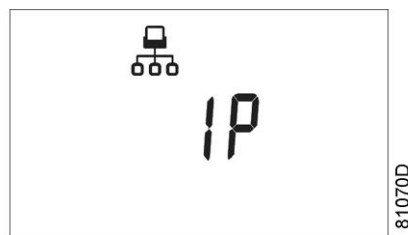

### Modification

Press the Enter button (13) and if necessary enter the password. The first digits are blinking. Use the Scroll buttons Up or Down (12) to modify the settings and press Enter (13) to confirm. Modify the next digits the same way. The standard IP address is set as 192.168.100.100.

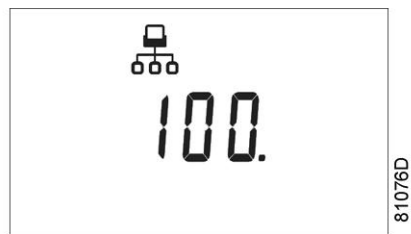

### 3.19 Calling up/modifying pressure band settings

#### Calling up the settings

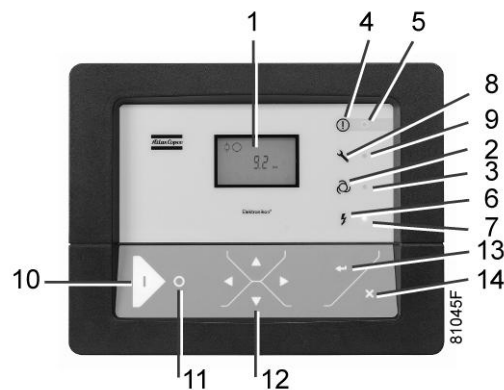

Starting from the Main screen:



- Press Scroll button (12) until <P.04> is shown and then press Enter button (13). Pressure band 1 (<Pb.1>) is shown on the display. Button (12) can be used to scroll to pressure band 2 (<Pb.2>).
- Press Enter button (13) on the desired pressure band. The load level of the selected pressure band appears. Button (12) can be used to scroll to the unload level.

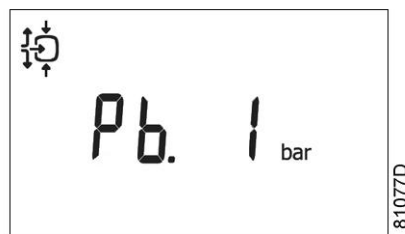

*Loading pressure*



*Unloading pressure*

## Modification

- Press Enter button (13) to modify the load level (value starts blinking). A password may be required. Use Scroll buttons (12) to change the loading pressure.

- Press Enter button (13) to program the new values or press the Escape button (14) to cancel.

### 3.20 Modifying the pressure band selection

#### Control panel

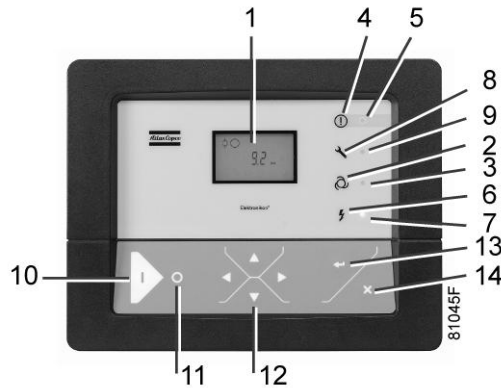

Starting from the Main screen:

- Press Scroll button (12) until <P.05> is shown and then press Enter button (13). The active pressure band 1 (<Pb.1>) is shown on the display.
- Press Enter button (13) to modify the pressure band selection (a password may be required). The active pressure band <Pb.1> starts blinking.
- Press button (12) to modify the active pressure band. Press Enter button (13) to confirm or the Escape button (14) to cancel.

### 3.21 Calling up/modifying service timer settings

#### Control panel

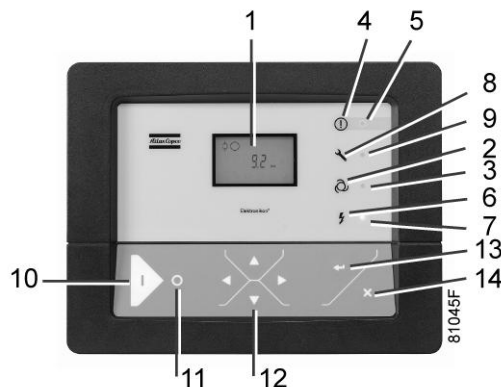

Starting from the Main screen:

- Press Scroll button (12) until <P. 6> is shown and then press Enter button (13): the setting of the service timer is shown in <hrs> (hours) or <x1000 hrs> (hours x 1000). Example: <4000 hrs> means the timer is set at 4000 running hours.

- Press Enter button (13) to modify this value (a password may be required): the value blinks. Use the Scroll buttons (12) to modify the setting.
- Press Enter button (13) to program the new value.

## 3.22 Calling up/modifying the unit of temperature

### Control panel

Starting from the Main screen:

- Press Scroll button (12) until <P.07> is shown and then press Enter button (13). The actually used unit is shown. Possible settings are <°C> and <°F>.
- Press Enter button (13) (unit blinks) and use the Scroll buttons (12) to select another unit of temperature.
- Press Enter button (13) to program the new unit or press Escape button (14) to return to the parameter screen without changes.

## 3.23 Calling up/modifying unit of pressure

### Control panel

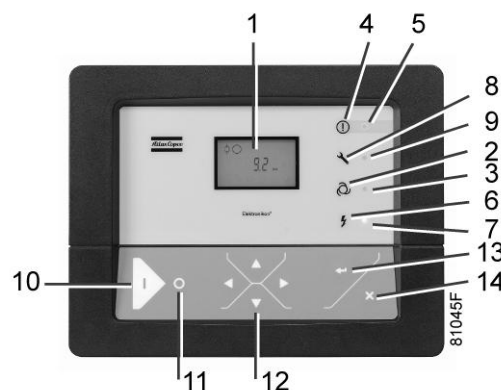

Starting from the Main screen:

- Press Scroll button (12) until <P.08> and the possible settings are shown (<Mpa>, <psi>, and <bar>). Press Enter button (13) and the actually used unit is shown.
- Press Enter button (13) (unit starts blinking) and use the Scroll buttons (12) to select another unit of pressure.
- Press Enter button (13) to program the new unit of pressure. Press the escape button (14) to return to the parameter screens.

## 3.24 Activating automatic restart after voltage failure

### Description

This function allows the compressor to restart automatically after a power failure.

This parameter, accessible in screen <P. 9>, can only be modified after entering a code. Consult your supplier if this function is to be activated.

For compressors leaving the factory, this function is made inactive. If desired, the function can be activated. The ARAVF label 1079 9932 74( see section Pictographs ) shall be glued near to the controller. Consult your local supplier.



### 3.25 Selection between Y-D or DOL starting

#### Control panel

Starting from the Main screen:

- Press Scroll button (12) until <P.10> and the motor pictograph is shown and then press Enter button (13). The actually used starting mode is shown: <Y-D> (star-delta) or <doL> (Direct-On-Line).
- For obvious reasons, this parameter must normally not be altered. Therefore it can only be modified after entering a secure code. Consult Atlas Copco if the parameter is to be changed.



*Example of Y-D setting*

## 3.26 Calling up modifying load delay time

### Control panel

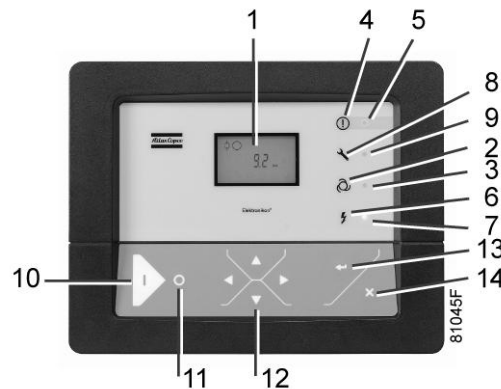

- Starting from the Main screen, press Scroll button (12) until <P.11> and the compressor load pictograph is shown and press the Enter button (13).  
Following screen appears:

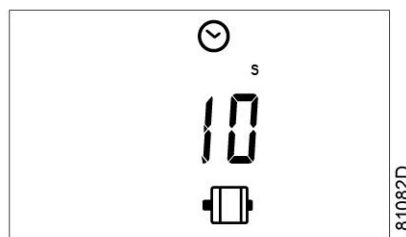

- This screen shows the load delay time (10) and the unit (s= seconds). To modify this value press the Enter button (13) (a password may be required).
- The value starts blinking and Scroll buttons (12) can be used to modify the value.
- Press the Enter button (13) to program the new value.

The minimum and maximum value depends on the parameters.

## 3.27 Calling up modifying minimum stop time

Starting from the Main screen:

- Press the Scroll button (12) until <P.12> and the motor pictograph is shown and press the Enter button (13):

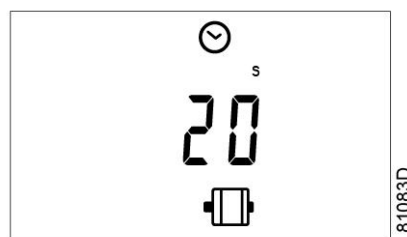

- This screen shows the minimum stop time (20) and the unit <s> (seconds).
- To modify this value press the Enter button (13). The value starts blinking and Scroll buttons (12) can be used to modify this value.

- Press Enter button (13) to program the new value.  
The minimum and maximum values depend on the parameters.

### 3.28 Activating password protection

Important settings such as the setting of the service timer, pressure band setting, control mode settings,... can be protected by a password.

Starting from the Main screen:

- Press Scroll buttons (12) until <P.13> is shown and press Enter button (13):



- Password (<PASS>) appears on the screen. Press the Enter button (13).
- The screen shows the password status (ON (<On>) or OFF (<OFF>)). Press Enter button (13) to modify.
- Change the value with Scroll buttons (12).
- Select <On> and press Enter button (13).
- Enter the new password and press Enter button (13) to confirm.
- Enter the password again and press Enter button (13) to confirm.
- <On> appears on the display. Press reset key to return to the parameter screen.

	Lost passwords can not be recovered. Save the password carefully.
---	---

### 3.29 Activate load/unload remote pressure sensing

Starting from the Main screen:

- Press the Scroll button (12) until <P.14> appears
- Press the Enter button (13).

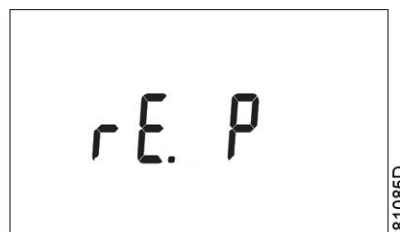

- The function of this screen is to activate the remote load/unload relay. To be able to activate this remote Load/Unload functionality, a physical digital input with function Load/Unload is required.

Once this parameter is activated, the physical digital input can be used to switch the compressor between Load and Unload.

### 3.30 Calling up/modifying protection settings

#### Available protections

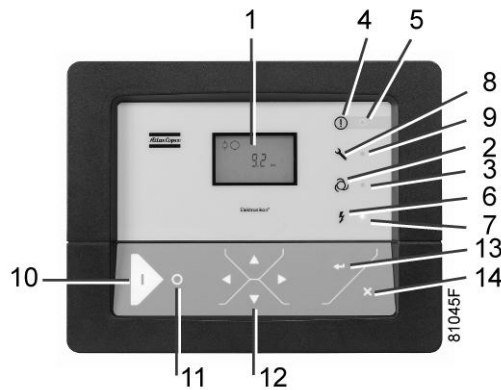

A number of protection settings are provided. The protection screens are labelled <Pr.>. The pictograph shown with the protection screen indicates the purpose of the protection.

Possible combinations are <Pr.>, followed by a number and one of the next pictographs:

Pictograph	Designation
	<Pr.> combined with the pressure pictograph shows the pressure protections.
	<Pr.> combined with the element outlet temperature pictograph shows the element outlet temperature protections.
	<Pr.> combined with the dew point temperature pictograph shows the dew point temperature protections.
	<Pr.> combined with the ambient temperature pictograph shows the ambient temperature protections.

#### Following protection settings are available:

- A low warning level, shown on the display as <AL-L>.
- A high warning level, shown on the display as <AL-H>.
- A low shutdown level, shown on the display as <Sd-L>.
- A high shutdown level, shown on the display as <Sd-H>.
- A low service level shown on the display as <SE-L>.
- A high service level shown on the display as <SE-H>.

**Example of protection screens**

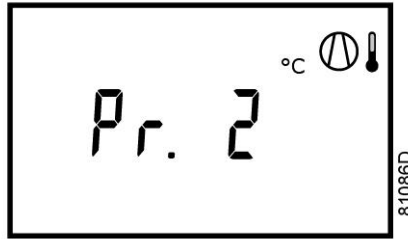

In this menu the temperature protection settings can be checked and modified.

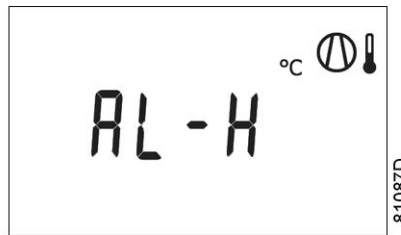

**Changing the settings**

Starting from the Main screen (the example given describes the protection of the element outlet temperatures):

Press Scroll buttons (12) until <Pr.>, followed by a number and the element outlet temperature pictograph is shown and press Enter button (13):

- The warning level for the high temperature warning level <AL-H> and the high temperature shutdown level <Sd-H> become visible. Use Scroll keys (12) to move between the warning level (<AL>) and the shutdown level (<Sd>), press the Enter button (13) to modify the value.
- An optional password may be required, the value starts blinking and Scroll buttons (12) can be used to modify the value.
- Press the Enter button (13) to program the new value.

	Programmable settings can only be modified within allowed limits.
---	---

### 3.31 Test screens

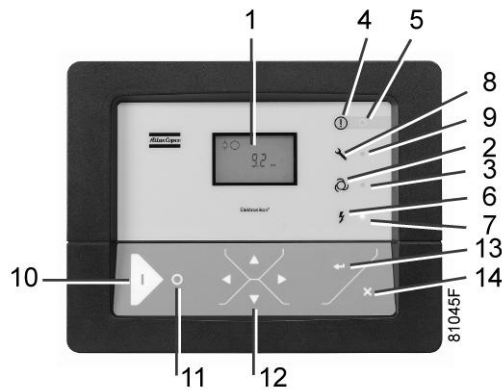

#### Display test

Starting from the Main screen, press Scroll buttons (12) until <t. 1> is shown and then press Enter button (13).

The display now shows all icons that can be displayed:

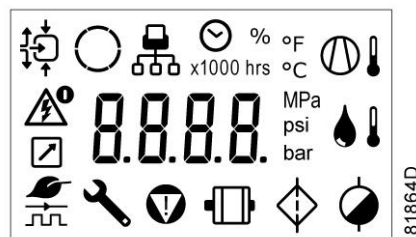

#### Safety valve test

In the test screen <t. 2>, a safety valve test is provided. The safety valves can only be tested after entering a code. Consult Atlas Copco if the safety valves are to be tested.

#### Production test

Test screen <t. 3> is only intended for production test. If the Main screen shows following screen, the controller is in production test mode:



How to solve?

Use the Scroll buttons (12) and scroll to menu <t. 3>.

The screen shows:

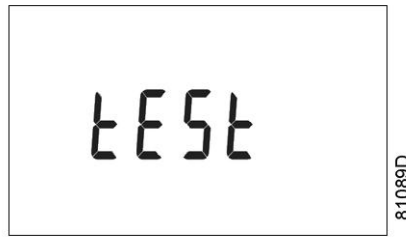

Press the Enter button (13): the text starts blinking. Press enter again and the menu disappears.

### 3.32 Web server

All controllers have a built-in web server that allows direct connection to the company network or to a dedicated PC via a local area network (LAN). This allows to consult certain data and settings via a PC instead of the display of the controller.

#### Getting started

Make sure you are logged in as administrator.

- Use the internal network card from your computer or a USB to LAN adapter.
- Use a UTP cable (CAT 5e) to connect to the controller (see picture below).



#### Configuration of the network card

- Go to Network and Sharing Center (1).

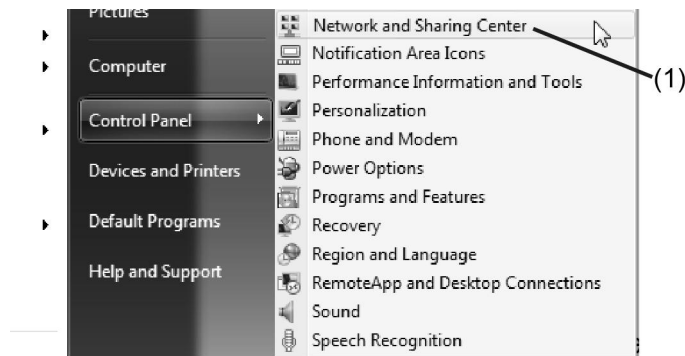

60651D

- Click on Change adapter settings (1).

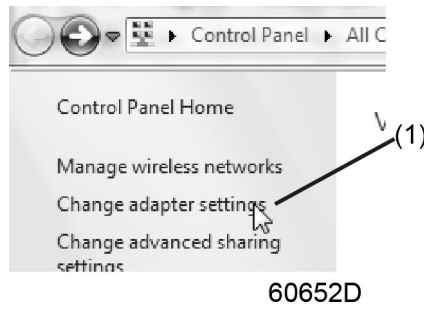

60652D

- Select the Local Area Connection, which is connected to the controller.



60653D

- Click with the right button and select Properties (1).

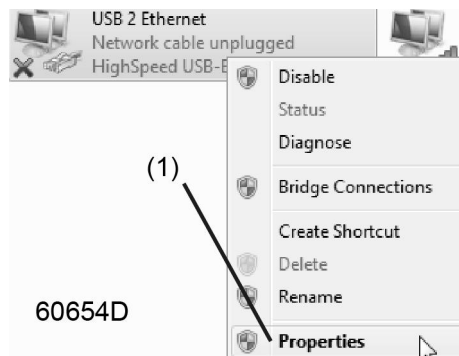

60654D

- Use the check box Internet Protocol version +4 (TCP/IPv4) (1) (see picture). To avoid conflicts, uncheck other properties if they are checked. After selecting TCP/IPv4, click on the Properties button (2) to change the settings.

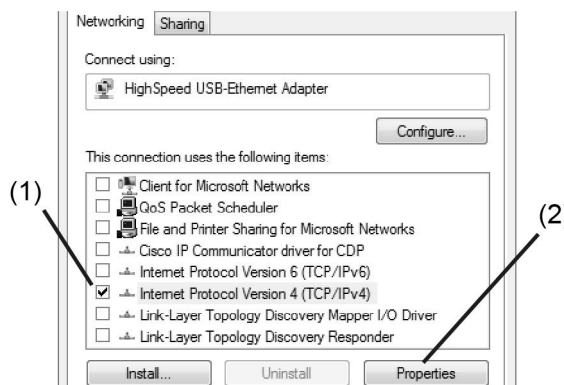

60655D

- Use the following settings:
  - IP Address 192.168.100.200 (1)
  - Subnetmask 255.255.255.0 (2)
- Click OK (3) and close network connections.

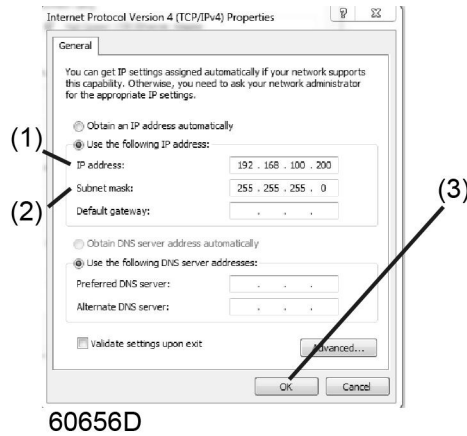

60656D

### Configure a company network (LAN) connection

- Ask your IT department to generate a fixed IP address in your company's network.
- That IP address will be excluded from the DNS server, so it will be reserved for the controller.
- Also get the correct Gateway and Subnet mask settings. For example:
  - IP = 10.25.43.200
  - Gateway = 10.25.42.250
  - Subnet mask = 255.255.254.0
- Connect the controller to the company's network (LAN) by using a UTP cable (min. CAT 5e).



81508D

- Adapt the network settings in the controller:
  - Go to Main Menu



60657D

- Go to Settings (1)

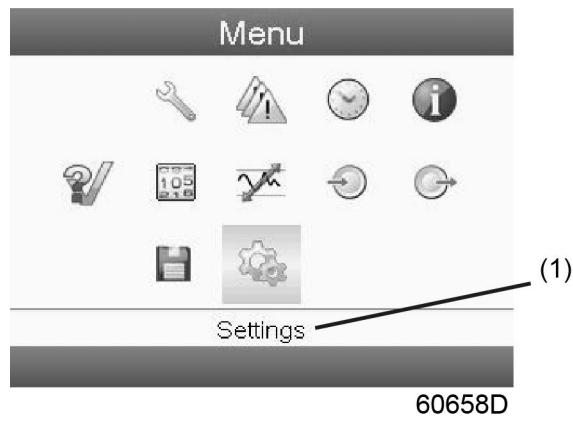

- Go to Network (1)

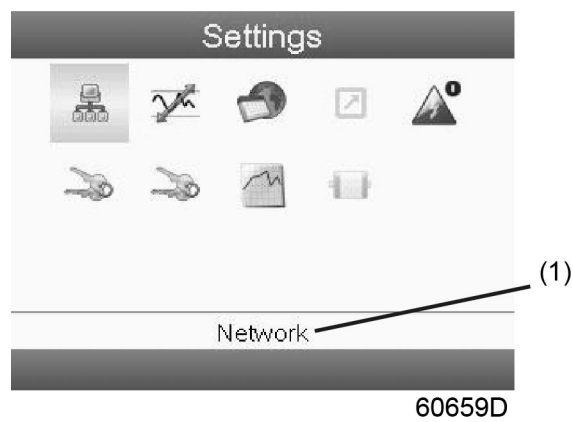

- Go to Ethernet (1)

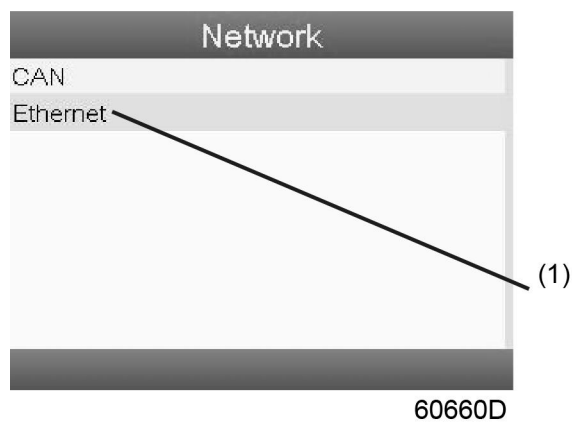

- Switch Off (1) the Ethernet communication to allow editing the settings

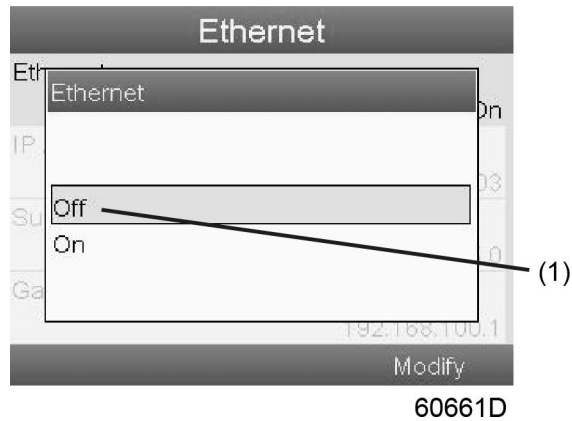

- Adapt IP Address (1)
- Adapt Gateway IP (2)
- Adapt Subnet Mask (3)
- Switch On (4) the Ethernet communication

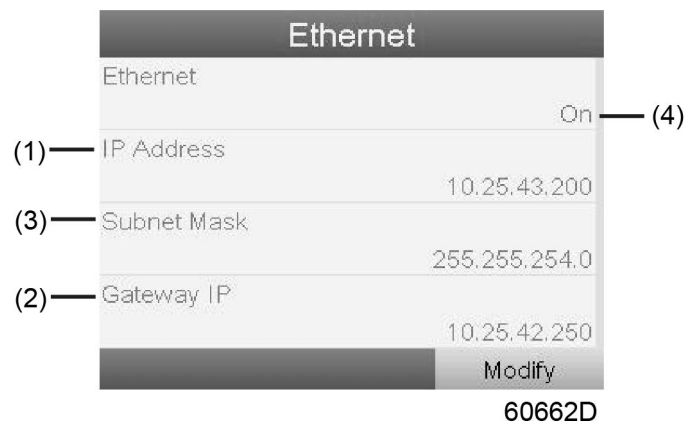

- Wait a few minutes so the LAN network can connect to the controller

### Configuration of the web server

The internal web server is designed and tested for Microsoft® Internet Explorer.

Also **"Opera"**, **"Mozilla Firefox"**, **"Safari"** and **"Chrome"** should work.

### Viewing the controller data

	All screen shots are indicative. The number of displayed fields depends on the selected options.
--	--

- Open your browser and type the IP address of the controller you want to view in your browser (in this example <http://192.168.100.100>). The interface opens:

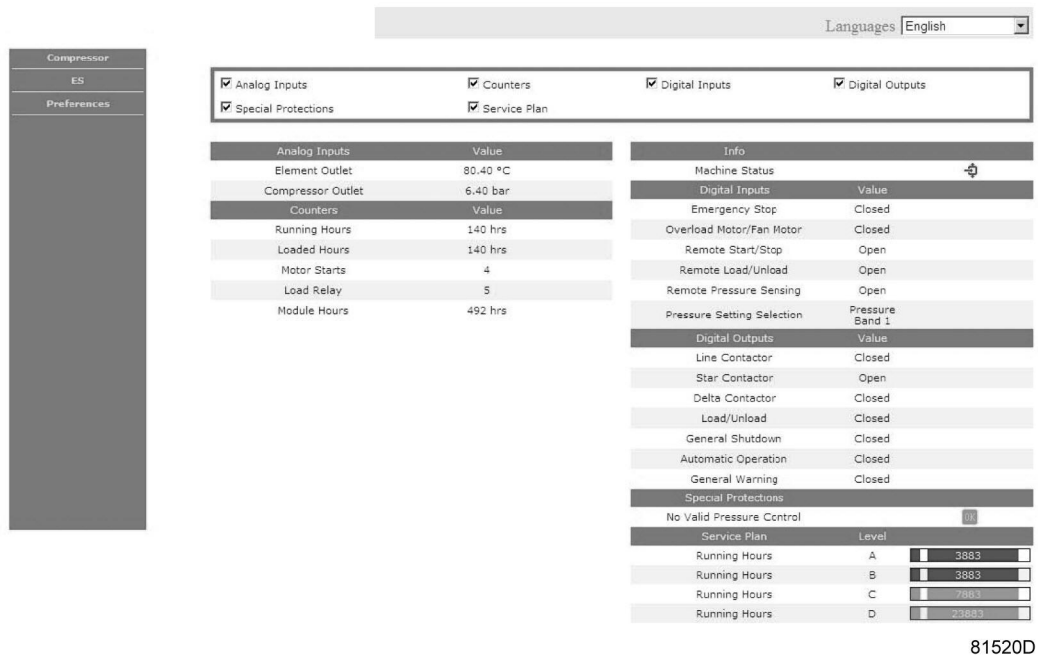

Screen shot (example!)

### Navigation and options

- The banner shows the unit type and the language selector. In this example, three languages are available on the controller.



- On the left side of the interface, you can find the navigation menu. If a license for ESi is foreseen, the menu contains 3 buttons.
  - Machine: shows all generator settings.
  - ES: shows the ESi status (if a license is provided).
  - Preferences: allows to change temperature and pressure unit.

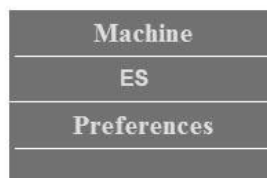

### Unit settings

All unit settings can be displayed or hidden. Put a check mark in front of each point of interest and it will be displayed. Only the machine status is fixed and can not be removed from the main screen.

#### Analog inputs

Lists all current analog input values. The measurement units can be changed in the preference button from the navigation menu.

Analog Inputs

Analog Inputs	Value
Element Outlet	131.90 °F
Compressor Outlet	110.21 psi

81523D

#### Counters

Lists all current counter values from controller and unit.

Counters

Counters	Value
Running Hours	29 hrs
Loaded Hours	29 hrs
Motor Starts	3
Load Relay	4
Module Hours	549 hrs

81524D

#### Info status

Machine status is always shown on the web interface.

Info
Machine Status

81525D

#### Digital inputs

Lists all digital inputs and their status.

Digital Inputs

Digital Inputs	Value
Emergency Stop	Closed
Overload Motor/Fan Motor	Closed
Remote Start/Stop	Open
Remote Load/Unload	Open
Remote Pressure Sensing	Open
Pressure Setting Selection	Pressure Band 1

81526D

#### Digital outputs

Lists all digital outputs and their status.

Digital Outputs

Digital Outputs	Value
Line Contactor	Closed
Star Contactor	Open
Delta Contactor	Closed
Load/Unload	Closed
General Shutdown	Closed
Automatic Operation	Closed
General Warning	Closed

81527D

### Special protections

Lists all special protections of the unit.

Special Protections

Special Protections
No Valid Pressure Control

OK

81528D

### Service plan

Displays all levels of the service plan and their status. This screen shot underneath only shows the running hours. It is also possible to show the current status of the service interval.

Service Plan

Service Plan	Level	Running Hours
Running Hours	A	3971
Running Hours	B	3971
Running Hours	C	7971
Running Hours	D	23971

81529D

## 3.33 Programmable settings

Parameters: unloading/loading pressures for compressors without built-in refrigeration dryer

		Minimum setting	Factory setting	Maximum setting
<b>Unloading pressures</b>				
Unloading pressure (7.5 bar compressors)	bar(e)	4.1	7	7.5
Unloading pressure (7.5 bar compressors)	psig	59.5	101.5	108.8
Unloading pressure (8.5 bar compressors)	bar(e)	4.1	8	8.5
Unloading pressure (8.5 bar compressors)	psig	59.5	116	123.5
Unloading pressure (10 bar compressors)	bar(e)	4.1	9.5	10
Unloading pressure (10 bar compressors)	psig	59.5	137.8	145.0
Unloading pressure (13 bar compressors)	bar(e)	4.1	12.5	13
Unloading pressure (13 bar compressors)	psig	59.5	181.3	188.6
Unloading pressure (100 psi compressors)	bar(e)	4.1	6.9	7.4

		<b>Minimum setting</b>	<b>Factory setting</b>	<b>Maximum setting</b>
Unloading pressure (100 psi compressors)	psig	59.5	100	107.3
Unloading pressure (125 psi compressors)	bar(e)	4.1	8.6	9.1
Unloading pressure (125 psi compressors)	psig	59.5	125	132
Unloading pressure (150 psi compressors)	bar(e)	4.1	10.3	10.8
Unloading pressure (150 psi compressors)	psig	59.5	150	156.6
Unloading pressure (175 psi compressors)	bar(e)	4.1	12	12.5
Unloading pressure (175 psi compressors)	psig	59.5	175	181.2
<b>Loading pressures</b>				
Loading pressure (7.5 bar compressors)	bar(e)	4	6.4	7.4
Loading pressure (7.5 bar compressors)	psig	58	92.8	107.3
Loading pressure (8.5 bar compressors)	bar(e)	4	7.4	8.4
Loading pressure (8.5 bar compressors)	psig	58	107.3	121.8
Loading pressure (10 bar compressors)	bar(e)	4	8.9	9.9
Loading pressure (10 bar compressors)	psig	58	129.1	143.6
Loading pressure (13 bar compressors)	bar(e)	4	11.9	12.9
Loading pressure (13 bar compressors)	psig	58	172.6	187.1
Loading pressure (100 psi compressors)	bar(e)	4	6.3	7.3
Loading pressure (100 psi compressors)	psig	58	91.4	105.9
Loading pressure (125 psi compressors)	bar(e)	4	8	9
Loading pressure (125 psi compressors)	psig	58	116	130.5
Loading pressure (150 psi compressors)	bar(e)	4	9.7	10.7
Loading pressure (150 psi compressors)	psig	58	140.7	155.2
Loading pressure (175 psi compressors)	bar(e)	4	11.4	12.4
Loading pressure (175 psi compressors)	psig	58	165.3	179.8

**Parameters: unloading/loading pressures for compressors with built-in refrigeration dryer**

		<b>Minimum setting</b>	<b>Factory setting</b>	<b>Maximum setting</b>
<b>Unloading pressures</b>				
Unloading pressure (7.5 bar compressors)	bar(e)	4	7	7.3
Unloading pressure (7.5 bar compressors)	psig	58	101.5	106
Unloading pressure (8.5 bar compressors)	bar(e)	4	8.0	8.3
Unloading pressure (8.5 bar compressors)	psig	58	116	120.5
Unloading pressure (10 bar compressors)	bar(e)	4	9.5	9.8
Unloading pressure (10 bar compressors)	psig	58	137.8	142
Unloading pressure (13 bar compressors)	bar(e)	4	12.5	12.8
Unloading pressure (13 bar compressors)	psig	58	181.3	185.5
Unloading pressure (100 psi compressors)	bar(e)	4	6.9	7.2
Unloading pressure (100 psi compressors)	psig	58	100	104.5
Unloading pressure (125 psi compressors)	bar(e)	4	8.6	8.9

		<b>Minimum setting</b>	<b>Factory setting</b>	<b>Maximum setting</b>
Unloading pressure (125 psi compressors)	psig	58	125	129
Unloading pressure (150 psi compressors)	bar(e)	4	10.3	10.6
Unloading pressure (150 psi compressors)	psig	58	150	153.5
Unloading pressure (175 psi compressors)	bar(e)	4	12	12.3
Unloading pressure (175 psi compressors)	psig	58	175	178.4
Loading pressures				
Loading pressure (7.5 bar compressors)	bar(e)	4	6.4	7.2
Loading pressure (7.5 bar compressors)	psig	58	92.8	104.5
Loading pressure (8.5 bar compressors)	bar(e)	4	7.4	8.2
Loading pressure (8.5 bar compressors)	psig	58	107	119
Loading pressure (10 bar compressors)	bar(e)	4	8.9	9.7
Loading pressure (10 bar compressors)	psig	58	129.1	140.5
Loading pressure (13 bar compressors)	bar(e)	4	11.9	12.7
Loading pressure (13 bar compressors)	psig	58	172.6	184
Loading pressure (100 psi compressors)	bar(e)	4	6.3	7.1
Loading pressure (100 psi compressors)	psig	58	91.4	103
Loading pressure (125 psi compressors)	bar(e)	4	8	8.8
Loading pressure (125 psi compressors)	psig	58	116	127.5
Loading pressure (150 psi compressors)	bar(e)	4	9.7	10.5
Loading pressure (150 psi compressors)	psig	58	140.7	152.5
Loading pressure (175 psi compressors)	bar(e)	4	11.4	12.2
Loading pressure (175 psi compressors)	psig	58	165.3	177

**Parameters**

		<b>Minimum setting</b>	<b>Factory setting</b>	<b>Maximum setting</b>
Motor running time in star	sec	5	10	10
Load delay time (star-delta)	sec	0	0	10
Number of motor starts	starts/day	0	240	240
Minimum stop time	sec	10	20	30
Programmed stop time	sec	0	3	20
Power recovery time (ARAVF)	sec	10	10	3600
Restart delay	sec	0	0	1200
Communication time-out	sec	10	30	60

## Protections

		Minimum setting	Factory setting	Maximum setting
Compressor element outlet temperature (shut-down warning level)	°C	50	110	119
Compressor element outlet temperature (shut-down warning level)	°F	122	230	246
Compressor element outlet temperature (shut-down level)	°C	111	120	120
Compressor element outlet temperature (shut-down level)	°F	232	248	248

## Service plan

The built-in service timer will give a Service warning message after a preprogrammed time interval has elapsed.

Also see section Preventive maintenance schedule.

Consult Atlas Copco if a timer setting has to be changed. See section [Calling up/modifying service timer settings](#). The intervals must not exceed the nominal intervals and must coincide logically.

## Terminology

Term	Explanation
ARAVF	Automatic restart after voltage failure. See section <a href="#">Elektronikon regulator</a> and <a href="#">Activating automatic restart</a> .
Power recovery time	Is the period within which the voltage must be restored to have an automatic restart. Is accessible if the automatic restart is activated. To activate the automatic restart function, consult Atlas Copco.
Restart delay	This parameter allows to programme that not all compressors are restarted at the same time after a power failure (ARAVF active).
Compressor element outlet	The regulator does not accept inconsistent settings, e.g. if the warning level is programmed at 95 °C (203 °F), the minimum limit for the shut-down level changes to 96 °C (204 °F). The recommended difference between the warning level and shut-down level is 10 °C (18 °F).
Delay at shut-down signal	Is the time for which the signal must exist before the compressor is shut down. If it is required to program this setting to another value, consult Atlas Copco.
Minimum stop time	Once the compressor has automatically stopped, it will remain stopped for the minimum stop time, whatever happens with the net air pressure. Consult Atlas Copco if a setting lower than 20 seconds is required.
Unloading/Loading pressure	The regulator does not accept illogical settings, e.g. if the unloading pressure is programmed at 7.0 bar(e) (101 psi(g)), the maximum limit for the loading pressure changes to 6.9 bar(e) (100 psi(g)). The recommended minimum pressure difference between loading and unloading is 0.6 bar (9 psi(g)).

## 4 Elektronikon™ Graphic controller

### 4.1 Controller

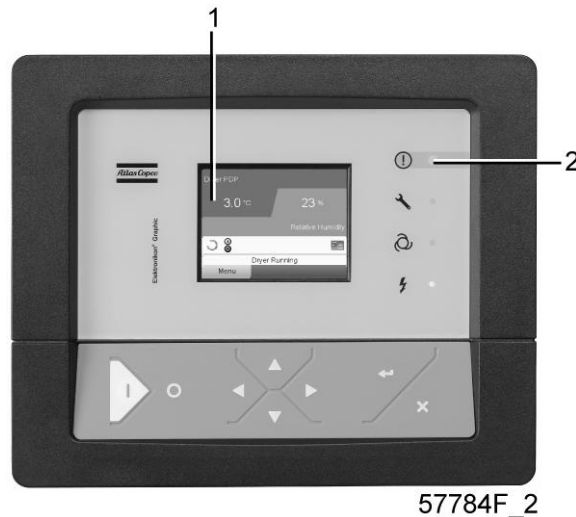

*The Elektronikon™ Graphic controller*

#### Introduction

**The Elektronikon™ controller has following functions:**

- Controlling the compressor
- Protecting the compressor
- Monitoring components subject to service
- Automatic restart after voltage failure (ARAVF)

#### Automatic control of the compressor

The controller maintains the net pressure between programmable limits by automatically loading and unloading the compressor (fixed speed compressors) or by adapting the motor speed (compressors with frequency converter). A number of programmable settings, e.g. the unloading and loading pressures (for fixed speed compressors), the setpoint (for compressors with frequency converter), the minimum stop time and the maximum number of motor starts and several other parameters are taken into account.

The controller stops the compressor whenever possible to reduce the power consumption and restarts it automatically when the net pressure decreases. If the expected unloading period is too short, the compressor is kept running to prevent too short standstill periods.



A number of time based automatic start/stop commands may be programmed. Take into account that a start command will be executed (if programmed and activated), even after manually stopping the compressor.

#### Protecting the compressor

##### Shutdown

Several sensors are provided on the compressor. If one of the measured signals exceeds the programmed shutdown level, the compressor will be stopped.

Example: If the compressor element outlet temperature exceeds the programmed shutdown level, the compressor will be stopped. This will be indicated on the display of the controller.

The compressor will also be stopped in case of overload of the drive motor.

The compressor will also be stopped in the event of overload of the fan motor.



Before remedying, consult the [Safety precautions](#).

### Shutdown warning

A shutdown warning level is a programmable level below the shutdown level.

If one of the measurements exceeds the programmed shutdown warning level, this will also be indicated to warn the operator before the shutdown level is reached.

The message disappears as soon as the warning condition disappears.

A warning will also appear if the dew point temperature is too high (on compressors with integrated dryer).

### Service warning

A number of service operations are grouped (called Service Plans). Each Service Plan has a programmed time interval. If the service timer exceeds a programmed value, this will be indicated on the display to warn the operator to carry out the service actions belonging to that Service Plan.

### Automatic restart after voltage failure

The controller has a built-in function to automatically restart the compressor when the voltage is restored after voltage failure. For compressors leaving the factory, this function is made inactive. If desired, the function can be activated. Consult the Atlas Copco Customer Centre.



If the function is activated and provided the regulator was in the automatic operation mode, the compressor will automatically restart if the supply voltage to the module is restored.

The ARAVF label (see section Pictographs) shall be glued near to the controller.

## 4.2 Control panel

### Elektronikon regulator

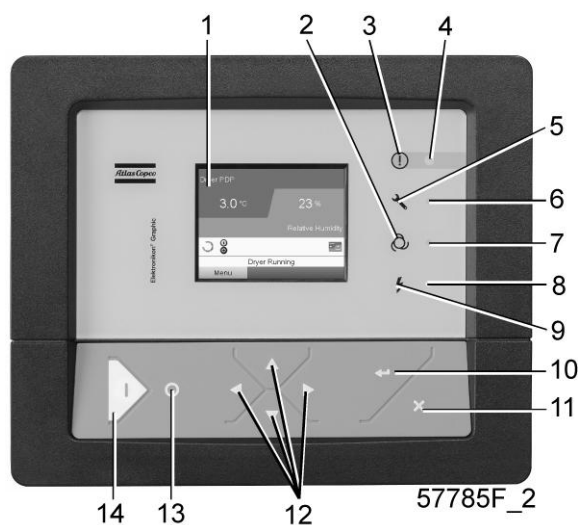











Control panel



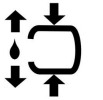





### Parts and functions

Reference	Designation	Function
1	Display	Shows the compressor operating condition and a number of icons to navigate through the menu.
2	Pictograph	Automatic operation
3	Pictograph	General alarm
4	Alarm LED	Flashes in case of a shut-down, is lit in case of a warning condition.
5	Pictograph	Service
6	Service LED	Lights up if service is needed
7	Automatic operation LED	Indicates that the regulator is automatically controlling the compressor.
8	Voltage on LED	Indicates that the voltage is switched on.
9	Pictograph	Voltage
10	Enter key	Use this button to confirm the last action.
11	Escape key	Use this button to go to previous screen or to end the current action.
12	Scroll keys	Keys to scroll through the menu.
13	Stop button	Button to stop the compressor. LED (7) goes out.
14	Start button	Button to start the compressor. LED (7) lights up indicating that the Elektronikon regulator is operative.





## 4.3 Icons used

### Status icons









Name	Icon	Description
Stopped / Running	 57786F	When the compressor is stopped, the icon stands still. When the compressor is running, the icon is rotating.
Compressor status	 57787F	Motor stopped
	 57788F	Running unloaded
	 57789F	Running loaded
	 84729D	Condensate prevention cycle
Machine control mode	 57790F or  59161F	Local start / stop
	 57791F	Remote start / stop
	 57792F	Network control
Automatic restart after voltage failure	 57793F	Automatic restart after voltage failure is active
Week timer	 57794F	Week timer is active

Active protection functions	 57795F	Emergency stop
	 57796F	Shutdown
	 57797F	Warning
Service	 57798F	Service required
Main screen display	 59162F	Value lines display icon
	 82196F	Chart display icon
General icons	 81105D	No communication / network problem
	 82418D	Not valid
	 57812F	General alarm









### Input icons





Icon	Description
 57799F	Pressure
 57800F	Temperature
 57801F	Digital input
 57802F	Special protection

### System icons



Icon	Description
 57803F	Compressor element
 57804F	Dryer
 57805F	Fan
 57806F	Frequency converter
 57807F	Drain
 57808F	Filter
 57809F	Motor
 57810F	Failure expansion module

### Menu icons

Icon	Description
 57813F	Inputs
 57814F	Outputs
 57812F	Alarms (Warnings, shutdowns)
 57815F	Counters
 57816F	Test
 57817F	Settings
 57798F	Service
 57818F	Event history (saved data)

 57819F	Access key / User password
 57792F	Network
 57820F	Setpoint
 57867F	Info

### Navigation arrows

Icon	Description
 57821F	Up
 57822F	Down

	This chapter gives a general survey of available icons. Not all icons mentioned in this chapter are applicable to every machine.
---	--

## 4.4 Main screen

### Control panel

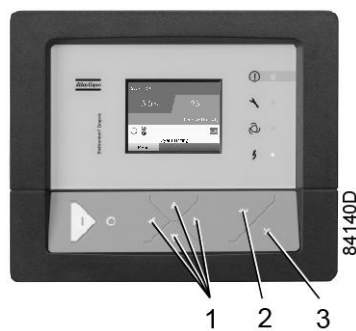

(1)	Scroll keys
(2)	Enter key
(3)	Escape key

## Function

The Main screen is the screen that is shown automatically when the voltage is switched on and one of the keys is pushed. It is switched off automatically after a few minutes when no keys are pushed.

Typically, 5 different main screen views can be chosen:

1. Two value lines
2. Four value lines
3. Chart (High resolution)
4. Chart (Medium resolution)
5. Chart (Low resolution)

### Two and four value lines screens

This type of Main screen shows the value of 2 or 4 parameters (see section [Inputs menu](#)).

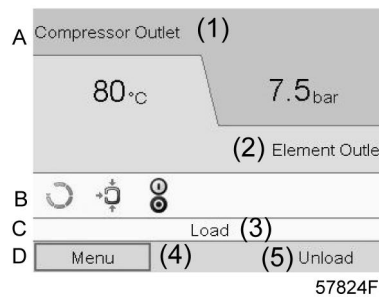

*Typical Main screen (2 value lines), fixed speed compressors*

### Text on image

(1)	Compressor Outlet
(2)	Element Outlet
(3)	Load, shutdown,... (text varies upon the compressors actual condition).
(4)	Menu
(5)	Unload, ES,... (text varies upon the compressors actual condition)



*Typical Main screen (4 value lines), fixed speed compressors*

Text on image

(1)	Compressor Outlet
(2)	Load Relay (one of the input signals of fixed speed compressors)
(3)	Off, Shutdown,... (text varies upon the compressors actual condition)
(4)	Menu
(5)	Running Hours
(6)	Element Outlet
(7)	Load, Unload,... (text varies upon the compressors actual condition)

- **Section A** shows information regarding the compressor operation (e.g. the outlet pressure or the temperature at the compressor outlet).
- **Section B** shows Status icons. Following icon types are shown in this field:
  - Fixed icons  
These icons are always shown in the main screen and cannot be selected by the cursor (e.g. compressor stopped or running, compressor status (running, running unloaded or motor stopped)).
  - Optional icons  
These icons are only shown if their corresponding function is activated (e.g. week timer, automatic restart after voltage failure , etc.)
  - Pop up icons  
These icons pop up if an abnormal condition occurs (warnings, shutdowns, service, ...)

To call up more information about the icons shown, select the icon concerned using the scroll keys and press the enter key.
- **Section C** is called the Status bar  
This bar shows the text that corresponds to the selected icon.
- **Section D** shows the Action buttons. These buttons are used:
  - To call up or program settings
  - To reset a motor overload, service message or emergency stop
  - To have access to all data collected by the regulator

The function of the buttons depends on the displayed menu. The most common functions are:

Designation	Function
Menu	To go to the menu
Modify	To modify programmable settings
Reset	To reset a timer or message

To activate an action button, highlight the button by using the Scroll keys and press the Enter key.  
To go back to the previous menu, press the Escape key.

Chart views

Instead of viewing values, it is also possible to view a graph of one of the input signals (see section [Inputs menu](#)) in function of the time.



59166D

When Chart (High Resolution) is selected, the chart shows the variation of the selected input (in this case the pressure) per minute. Also the instantaneous value is displayed. The screen shows the last 4 minutes.

The switch button (icon) for selecting other screens is changed into a small Chart and is highlighted (active).

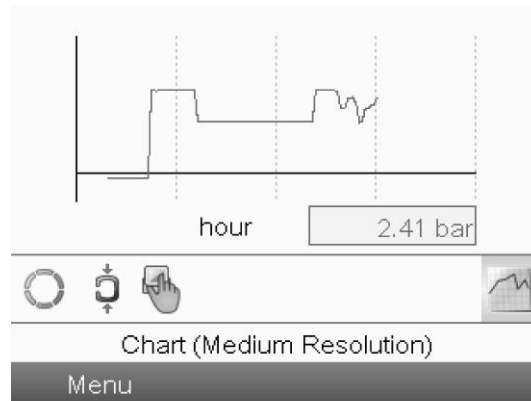

59167D

When the Chart (Medium Resolution) is selected, the chart shows the variation of the selected input per hour. The screen shows the last 4 hours.



59168D

When the Chart (Low Resolution) is selected, the chart shows the variation of the selected input per day. The screen shows the evolution over the last 10 days.

### Selection of a main screen view

To change between the different screen layouts, select the far right icon in the control icons line (see value lines display icon or chart display icon in section [Icons used](#)) and press the Enter key. A screen similar to the one below opens:

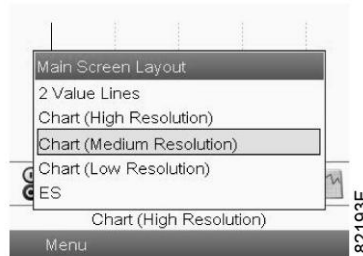

Select the layout required and press the Enter key. See also section [Inputs menu](#).

## 4.5 Calling up menus

### Control panel

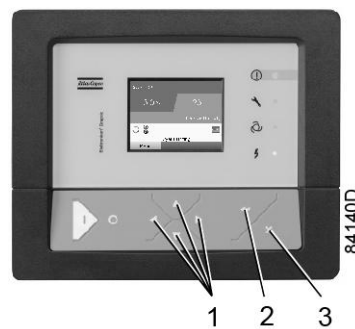

Control panel

(1)	Scroll keys
(2)	Enter key
(3)	Escape key

### Description

When the voltage is switched on, the main screen is shown automatically (see section [Main screen](#)):

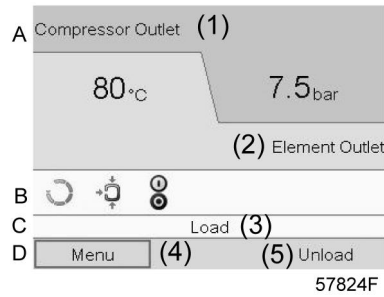

Typical Main screen (2 value lines), fixed speed compressors

Text on image

(1)	Compressor Outlet
(2)	Element Outlet
(3)	Load , shutdown ,.. (text varies upon the compressors actual condition).
(4)	Menu
(5)	Unload ,ES, ... (text varies upon the compressors actual condition

To go to the Menu screen, highlight Menu, using the Scroll keys.

- Press the Enter key to select the menu. Following screen appears:

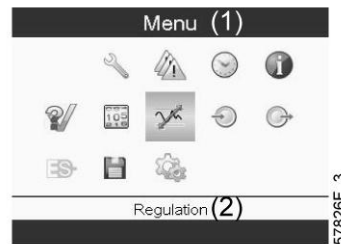

Typical menu screen

- The screen shows a number of icons. Each icon indicates a menu item. By default, the Pressure Settings (Regulation) icon is selected. The status bar shows the name of the menu that corresponds with the selected icon.
- Use the Scroll keys to select an icon.
- Press the Escape key to return to the Main screen.

## 4.6 Inputs menu

Menu icon, Inputs



**Function**

- To display the actual value of the measured data (analog inputs) and the status of the digital inputs (e.g. emergency stop contact, motor overload relay, etc.).
- To select the digital input to be shown on the chart in the main screen.

**Procedure**

Starting from the main screen,

- Move the cursor to the action button Menu and press the Enter key. Following screen appears:

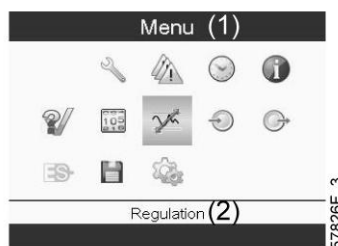

Text on image

(1)	Menu
(2)	Regulation

- Using the Scroll keys, move the cursor to the Inputs icon (see above, section Menu icon).
- Press the Enter key. A screen similar to the one below appears:

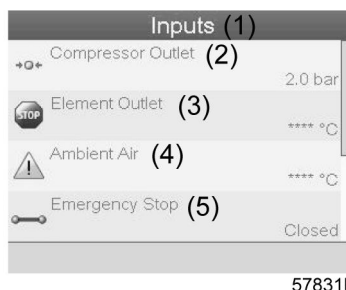

Text on image

(1)	Inputs
(2)	Compressor Outlet
(3)	Element Outlet
(4)	Ambient Air
(5)	Emergency Stop

- The screen shows a list of all inputs with their corresponding icons and readings.
- If an input is in warning or shutdown, the original icon is replaced by the warning or shutdown icon respectively (i.e. the Stop icon and the Warning icon in the screen shown above).

A small chart icon, shown below an item in the list means this input signal is shown on the chart at the main screen. Any analog input can be selected.

### Selecting another input signal as main chart signal

With the Modify button active (light grey background in above screen), press the Enter button on the controller. A screen similar to the one below appears:



The first item in the list is highlighted. In this example, the Net Pressure is selected (chart icon). To change, press the Enter button again: a pop-up window opens:



Press Enter again to remove this input from the chart. Another confirmation pop-up opens:

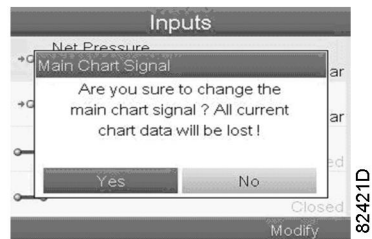

Select Yes to remove or No to quit the current action.

In a similar way, another input signal can be highlighted and selected as Main Chart signal:





(1): Set as main chart signal

## 4.7 Outputs menu

### Menu icon, Outputs



### Function

To call up information regarding the actual status of some outputs such as the condition of the Fan overload contact (on air cooled compressors), the Emergency stop contact, etc.

### Procedure

Starting from the Main screen,

- Move the cursor to the action button Menu and press the Enter key. Following screen appears:

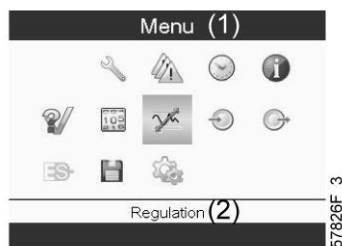

Text on image

(1)	Menu
(2)	Regulation

- Move the cursor to the Outputs icon (see above, section Menu icon, using the Scroll keys).
- Press the Enter key. A screen similar to the one below appears:

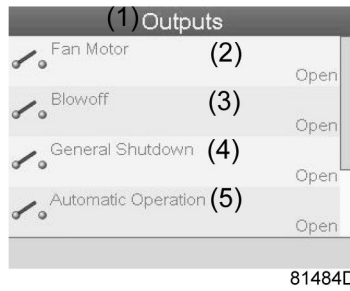

Outputs screen (typical)

Text on image

(1)	Outputs
(2)	Fan motor
(3)	Blowoff
(4)	General shutdown
(5)	Automatic operation

- The screen shows a list of all outputs with their corresponding icons and readings. If an output is in warning or shutdown, the original icon is replaced by the warning or shutdown icon respectively.

## 4.8 Counters

### Menu icon, Counters



### Function

To call up:

- The running hours
- The loaded hours
- The number of motor starts
- The number of hours that the regulator has been powered
- The number of load cycles

### Procedure

Starting from the Main screen (see [Main screen](#)),

- Move the cursor to the action button Menu and press the Enter key. Following screen appears:

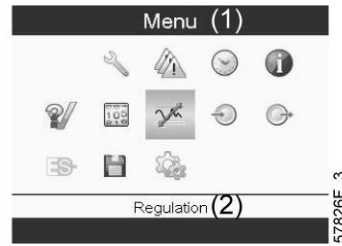

Text on image

(1)	Menu
(2)	Regulation

- Using the Scroll keys, move the cursor to the Counters icon (see above, section Menu icon)
- Press the Enter key. Following screen appears:

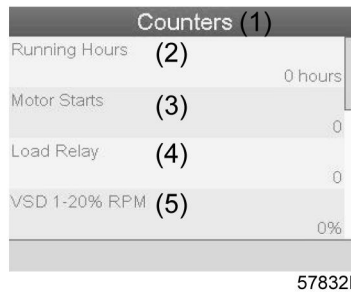

Text on image

(1)	Counters
(2)	Running Hours
(3)	Motor Starts
(4)	Load Relay
(5)	VSD 1-20 % RPM (the percentage of the time during which the motor speed was between 1 and 20 %) (compressors with frequency converter)

The screen shows a list of all counters with their actual readings.

**Note:** the example above is for a frequency converter driven compressor. For a fixed speed compressor, the actual screen will be somewhat different.

## 4.9 Control mode selection

### Function

To select the control mode, i.e. whether the compressor is in local control, remote control or controlled via a local area network (LAN).

### Procedure

Starting from the main screen, make sure the action button Menu (1) is selected:

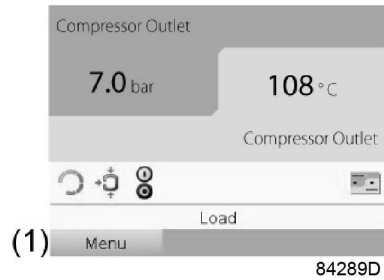

Next, use the scroll buttons to go to the Status icons (see section Main screen) and select the machine control icon (2).

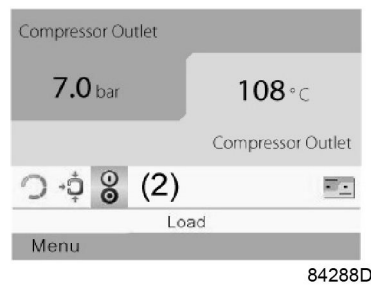

Press the enter button.

There are 3 possibilities:

- Local control
- Remote control
- LAN (network) control

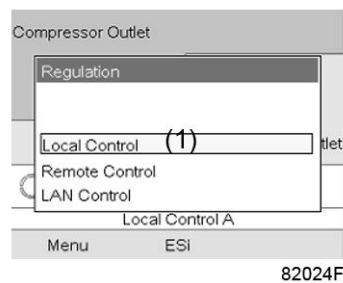

After selecting the required regulation mode, press the enter button on the controller to confirm your selection. The new setting is now visible on the main screen. See section [Used icons](#) for the meaning of the icons.

## 4.10 Service menu

### Control panel

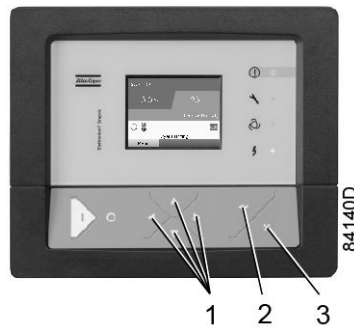

(1)	Scroll keys
(2)	Enter key
(3)	Escape key

### Menu icon, Service



### Function

- To reset the service plans which are carried out.
- To check when the next service plans are to be carried out.
- To find out which service plans were carried out in the past.
- To modify the programmed service intervals.

### Procedure

Starting from the Main screen,

- Move the cursor to the action button Menu and press the Enter key. Following screen appears:

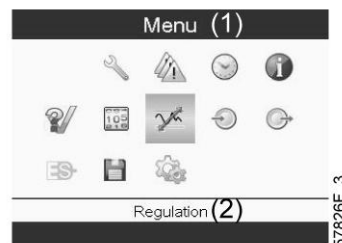

Text on image

(1)	Menu
(2)	Regulation

- Using the Scroll keys, move the cursor to the Service icon (see above, section Menu icon).
- Press the Enter key. Following screen appears:

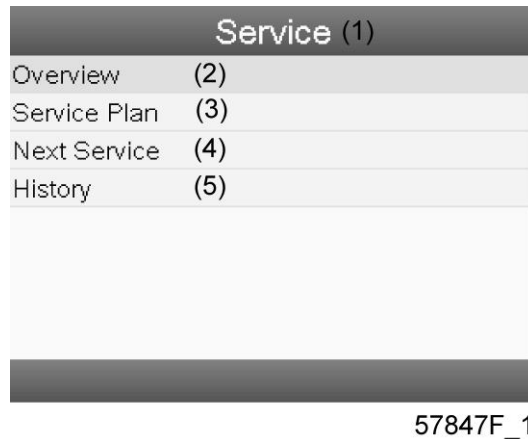

Text on image

(1)	Service
(2)	Overview
(3)	Service Plan
(4)	Next Service
(5)	History

- Scroll through the items to select the desired item and press the Enter key to see the details as explained below.

**Overview**

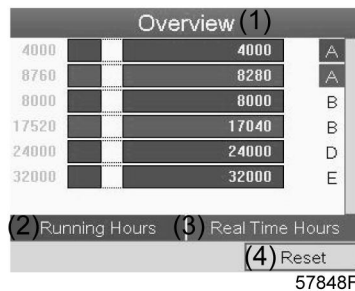

Text on image

(1)	Overview
(2)	Running Hours
(3)	Real Time Hours
(4)	Reset

Example for service level (A):

The figures at the left are the programmed service intervals. For Service interval A, the programmed number of running hours is 4000 hours (upper row) and the programmed number of real time hours is 8760 hours, which corresponds to one year (second row). This means that the controller will launch a service warning when either 4000 running hours or 8760 real hours are

reached, whichever comes first. Note that the real time hours counter keeps counting, also when the controller is not powered.

The figures within the bars are the number of hours to go till the next service intervention. In the example above, the compressor was just started up, which means it still has 4000 running hours and 8280 hours to go before the next Service intervention.

### Service plans

A number of service operations are grouped (called Level A, Level B, etc...). Each level stands for a number of service actions to be carried out at the time intervals programmed in the Elektronikon™ controller.

When a service plan interval is reached, a message will appear on the screen.

After carrying out the service actions related to the indicated levels, the timers must be reset.

From the Service menu above, select Service plan (3) and press Enter. Following screen appears:

Service Plan (1)		
(2) Level	(3) Running Hours	(4) Real Time
A	4000	8760
B	8000	17520
C		
D	24000	
E	32000	
		(5) Modify

57849F

Text on image

(1)	Service Plan
(2)	Level
(3)	Running hours
(4)	Real Time Hours
(5)	Modify

### Modifying a service plan

Dependant on the operating conditions, it can be necessary to modify the service intervals. To do so, use the Scroll keys to select the value to be modified. A screen similar to the one below appears:

Service Plan (1)		
(2) Level	(3) Running Hours	(4) Real Time
A	4000	8760
B	8000	17520
C		
D	24000	
E	32000	
		(5) Modify

57850F

Press the Enter key. Following screen appears:

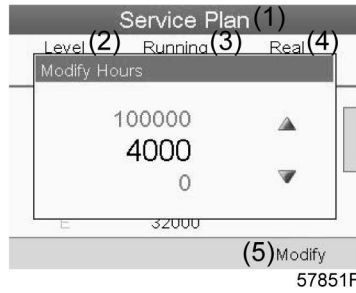

Modify the value as required using the ↑ or ↓ scroll key and press the Enter key to confirm.

**Note:** Running hours can be modified in steps of 100 hours, real time hours can be modified in steps of 1 hour.

### Next Service

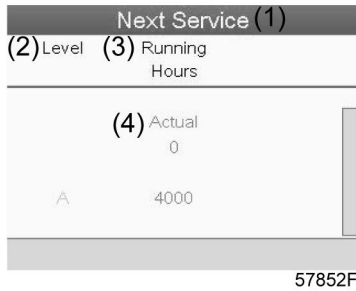

Text on image

(1)	Next service
(2)	Level
(3)	Running hours
(4)	Actual

In the example above, the A Service level is programmed at 4000 running hours, of which 0 hours have passed.

### History

The History screen shows a list of all service actions done in the past, sorted by date. The date at the top is the most recent service action. To see the details of a completed service action (e.g. Service level, Running hours or Real time hours), use the Scroll keys to select the desired action and press the Enter key.

## 4.11 Setpoint menu

### Control panel

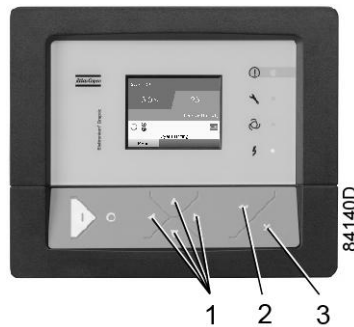

(1)	Scroll keys
(2)	Enter key
(3)	Escape key

### Menu icon, Setpoint



### Function

On fixed speed compressors, the operator can program two different pressure bands. This menu is also used to select the active pressure band.

### Procedure

Starting from the Main screen (see [Main screen](#)),

- Move the cursor to the action button Menu and press the Enter key. Following screen appears:

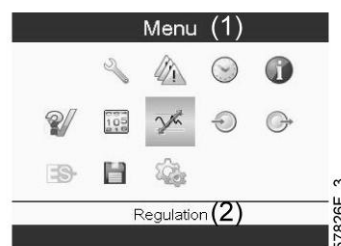

### Text on image

(1)	Menu
(2)	Regulation

- Move the cursor to the Setpoint icon (see above, section menu icon) using the Scroll keys.
- Press the Enter key. Following screen appears:

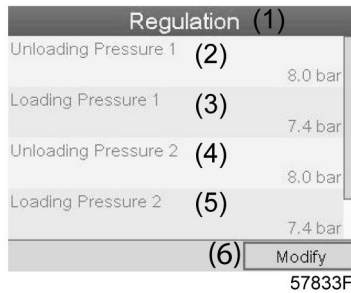

Text on image

(1)	Regulation
(2)	Unloading Pressure 1
(3)	Loading Pressure 1
(4)	Unloading Pressure 2
(5)	Loading Pressure 2
(6)	Modify

- The screen shows the actual unloading and loading pressure settings for both pressure bands.  
To modify the settings, move the cursor to the action button Modify and press the Enter key. Following screen appears:

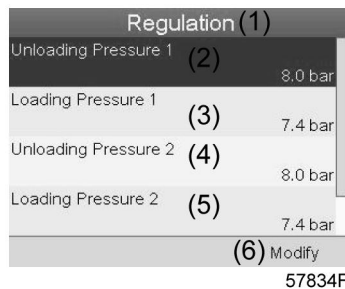

- The first line of the screen is highlighted in red. Use the Scroll keys to highlight the setting to be modified and press the Enter key. Following screen appears:

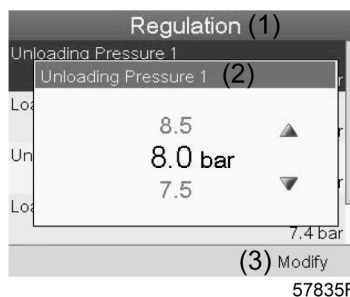

Text on image

(1)	Regulation
(2)	Unloading Pressure 1
(3)	Modify

- The upper and lower limit of the setting is shown in grey, the actual setting is shown in black. Use the ↑ or ↓ key of the Scroll keys to modify the settings as required and press the Enter key to accept.

If necessary, change the other settings as required in the same way as described above.

## 4.12 Event history menu

### Menu icon, Event History



### Function

To call up the last shutdown and last emergency stop data.

### Procedure

- Starting from the Main screen, move the cursor to the action button Menu and press the Enter key. Following screen appears:

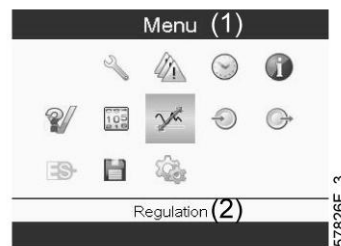

Text on image

(1)	Menu
(2)	Regulation

- Using the Scroll keys, move the cursor to the Event History icon (see above, section Menu icon)
- The list of last shutdown and emergency stop cases is shown.



Example of Event History screen

- Scroll through the items to select the desired shutdown or emergency stop event.

- Press the Enter key to find the date, time and other data reflecting the status of the compressor when that shutdown or emergency stop occurred.

### 4.13 Modifying general settings

#### Menu icon, Settings



#### Function

To display and modify a number of settings.

#### Procedure

Starting from the Main screen,

- Move the cursor to the action button Menu and press the Enter key. Following screen appears:

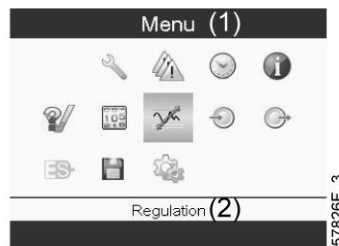

Text on image

(1)	Menu
(2)	Regulation

- Next, move the cursor to the Settings icon (see above, section menu icon), using the Scroll keys.
- Press the Enter key. Following screen appears:



This screen shows again a number of icons. By default, the User Password icon is selected. The status bar shows the description that corresponds with the selected icon. Each icon covers one or more items , such as

- Access key
- User password
- Main chart

- General
- Automatic restart after voltage failure (ARAVF)
- Network
- Regulation

For adapting certain parameters, a password may be necessary.

Example: Selecting the General Settings icon gives the possibility to change e.g. the language, the date, the date format, etc.:

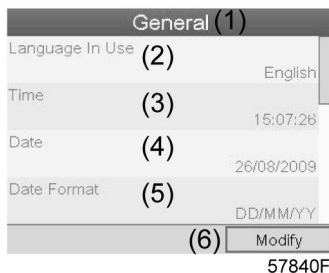

Text on image

(1)	General
(2)	Language in Use
(3)	Time
(4)	Date
(5)	Date Format
(6)	Modify

- To modify, select the Modify button using the Scroll keys and press the Enter key.
- A screen similar to the one above is shown, the first item (Language) is highlighted. Use the ↓ key of the Scroll keys to select the setting to be modified and press the Enter key.
- A pop-up screen appears. Use the ↑ or ↓ key to select the required value and press the Enter key to confirm.

## 4.14 Info menu

### Menu icon, Info



### Function

To show the Atlas Copco internet address.

### Procedure

Starting from the Main screen,

- Move the cursor to the action button Menu and press the Enter key. Following screen appears:

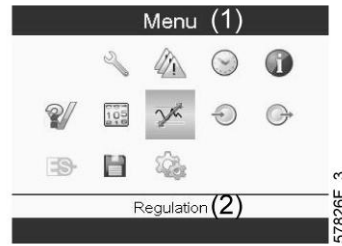

Text on image

(1)	Menu
(2)	Regulation

- Using the Scroll keys, move the cursor to the Info icon (see above, section Menu icon).
- Press the Enter key. The Atlas Copco internet address appears on the screen.

## 4.15 Week timer menu

### Menu icon, Week timer



### Function

- To program time based start/stop commands for the compressor
- To program time based changeover commands for the net pressure band
- Four different week schemes can be programmed.
- A week cycle can be programmed, a week cycle is a sequence of 10 weeks. For each week in the cycle, one of the four programmed week schemes can be chosen.

	<p><b>Important remark:</b>                  In the Elektronikon you can select different timers on one day (up to 8 actions). It is however not possible to program 2 actions at the same time. The solution: leave at least 1 minute in between 2 actions.                  Example: Start Compressor: 5.00 AM, Pressure Setpoint 2: 5.01 AM (or later).</p>
--	--

### Procedure

Starting from the Main screen (see section Main screen),

- Move the cursor to the action button Menu and press the Enter key. Use the Scroll buttons to select the Timer icon.

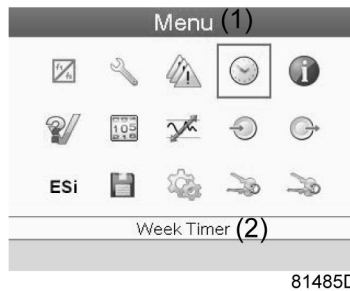

Text on image

(1)	Menu
(2)	Week Timer

- Press the Enter key on the controller. Following screen appears:

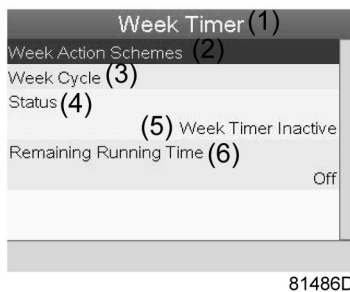

Text on image

(1)	Week Timer
(2)	Week Action Schemes
(3)	Week Cycle
(4)	Status
(5)	Week Timer Inactive
(6)	Remaining Running Time

The first item in this list is highlighted. Select the item requested and press the Enter key on the controller to modify.

### Programming week schemes

- Select Week action schemes and press Enter. A new window opens. The first item in the list is highlighted. Press the Enter key on the controller to modify Week Action Scheme 1.

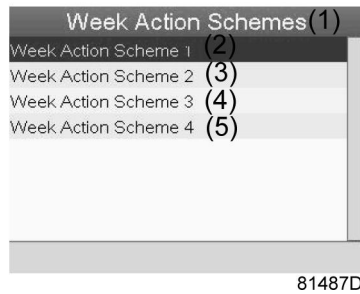

Text on image

(1)	Week Action Schemes
(2)	Week Action Scheme 1
(3)	Week Action Scheme 2
(4)	Week Action Scheme 3
(5)	Week Action Scheme 4

- A weekly list is shown. Monday is automatically selected and highlighted. Press the Enter key on the controller to set an action for this day.

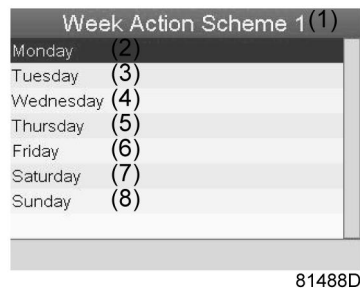

Text on image

(1)	Week Action Scheme 1
(2)	Monday
(3)	Tuesday
(4)	Wednesday
(5)	Thursday
(6)	Friday
(7)	Saturday
(8)	Sunday

- A new window opens. The Modify action button is selected. Press the enter button on the controller to create an action.

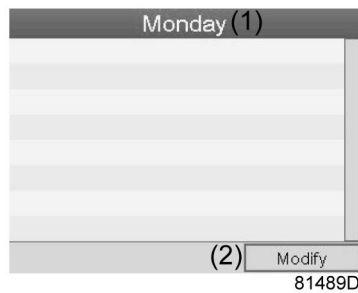

Text on image

(1)	Monday
(2)	Modify

- A new pop-up window opens. Select an action from this list by using the Scroll keys on the controller. When ready press the Enter key to confirm.

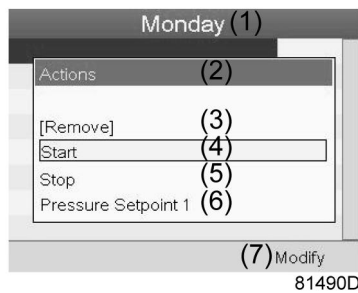

Text on image

(1)	Monday
(2)	Actions
(3)	Remove
(4)	Start
(5)	Stop
(6)	Pressure Setpoint 1
(7)	Modify

- A new window opens. The action is now visible in the first day of the week.

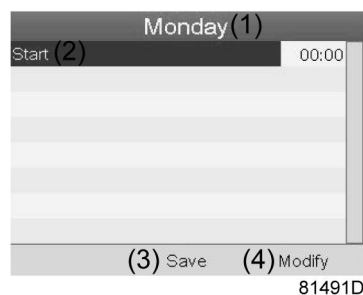

Text on image

(1)	Monday
(2)	Start
(3)	Save
(4)	Modify

- To adjust the time, use the Scroll keys on the controller to select the time and press the Enter key to confirm.

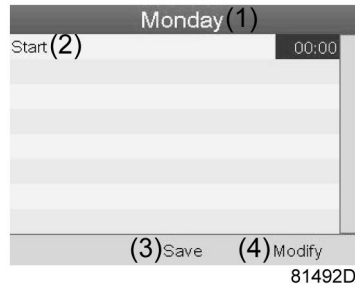

- A pop-up window opens. Use the ↑ or ↓ key of Scroll keys to modify the values of the hours. Use the ← or → Scroll keys to go to the minutes.

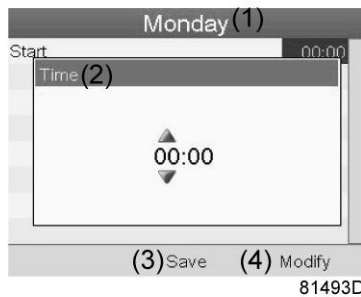

- Press the Escape key on the controller. The action button Modify is selected. Use the Scroll keys to select the action Save.

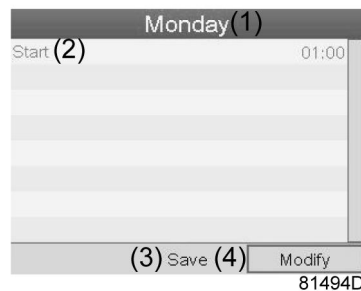

- A new pop-up window opens. Use the Scroll keys on the controller to select the required action. Press the Enter key to confirm.

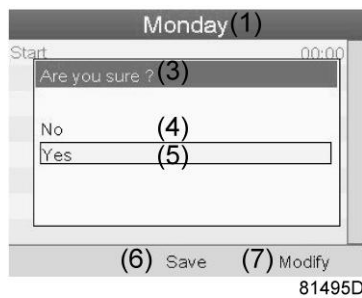

Text on image

(1)	Monday
(3)	Are you sure?
(4)	No
(5)	Yes
(6)	Save
(7)	Modify

Press the Escape key to leave this window.

- The action is shown below the day the action is planned.

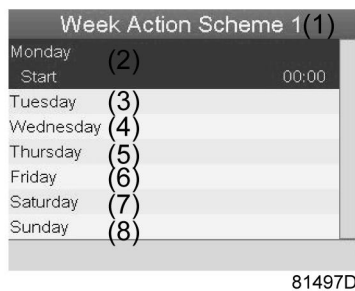

Text on image

(1)	Week Action Scheme 1
(2)	Monday
(3)	Tuesday
(4)	Wednesday
(5)	Thursday
(6)	Friday
(7)	Saturday
(8)	Sunday

Press the Escape key on the controller to leave this screen.

### Programming the week cycle

A week cycle is a sequence of 10 weeks. For each week in the cycle, one of the four programmed week schemes can be chosen.

- Select Week Cycle from the main Week Timer menu list.

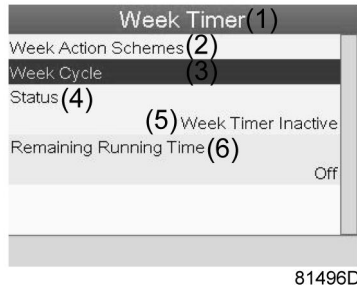

Text on image

(1)	Week Timer
(2)	Week Action Schemes
(3)	Week Cycle
(4)	Status
(5)	Week Timer Inactive
(6)	Remaining Running Time

- A list of 10 weeks is shown.

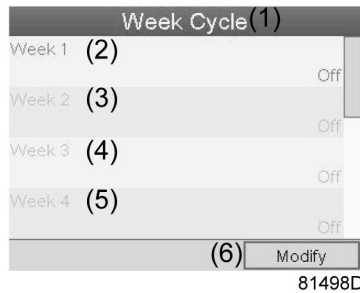

Text on image

(1)	Week Cycle
(2)	Week 1
(3)	Week 2
(4)	Week 3
(5)	Week 4
(6)	Modify

- Press twice the Enter key on the controller to modify the first week.
- A new window opens. Select the action, example: Week Action Scheme 1

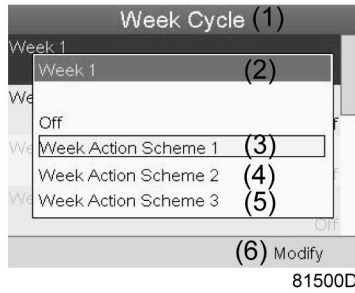

Text on image

(1)	Week Cycle
(2)	Week 1
(3)	Week Action Scheme 1
(4)	Week Action Scheme 2
(5)	Week Action Scheme 3
(6)	Modify

- Check the status of the Week Timer  
Use the Escape key on the controller to go back to the main Week Timer menu. Select the status of the Week Timer.

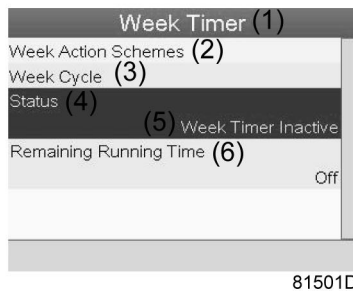

Text on image

(1)	Week Timer
(2)	Week Action Schemes
(3)	Week Cycle
(4)	Status
(5)	Week Timer Inactive
(6)	Remaining Running Time

- A new window opens. Select Week 1 to set the Week Timer active.

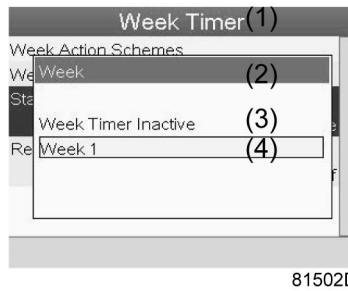

Text on image

(1)	Week Timer
(2)	Week
(3)	Week Timer Inactive
(4)	Week 1

- Press the Escape key on the controller to leave this window. The status shows that week 1 is active.

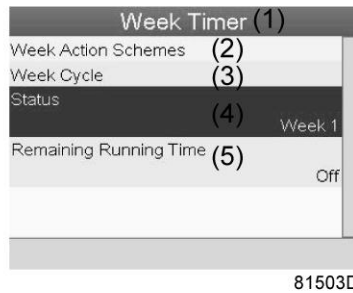

Text on image

(1)	Week Timer
(2)	Week Action Schemes
(3)	Week Cycle
(4)	Status
(5)	Remaining Running Time

- Press the Escape key on the controller to go to the main Week Timer menu. Select Remaining Running Time from the list and press the Enter key on the controller to Modify.



Text on image

(1)	Week Timer
(2)	Week Action Schemes
(3)	Week Cycle
(4)	Status
(5)	Remaining Running Time

- This timer is used when the week timer is set and for certain reasons the compressor must continue working, for example, 1 hour, it can be set in this screen. This timer is prior to the Week Timer action.

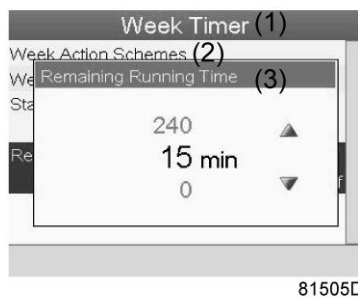

Text on image

(1)	Week Timer
(2)	Week Action Schemes
(3)	Remaining Running Time

## 4.16 Test menu

### Menu icon, Test



or



### Function

- To carry out a display test, i.e. to check whether the display and LED's are still intact.

### Procedure

Starting from the Main screen,

- Move the cursor to the action button Menu and press the enter key (2), following screen appears:

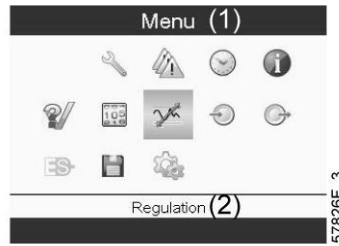

- Using the scroll keys (1), move the cursor to the test icon (see above, section Menu icon)
- Press the enter key (2), following screen appears:

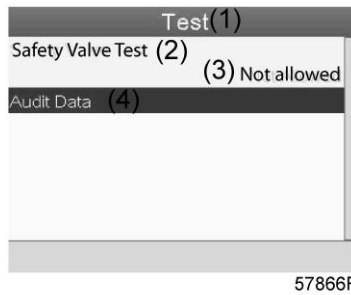

Text on image

(1)	Test
(2)	Safety Valve Test
(3)	Not allowed
(4)	Audit Data

- The safety valve test can only be performed by authorized personnel and is protected by a security code.
- Select the item display test and press the enter key. A screen is shown to inspect the display, at the same time all LED's are lit.

## 4.17 User password menu

### Menu icon, Password



### Function

If the password option is activated, it is impossible for not authorized persons to modify any setting.

### Procedure

Starting from the Main screen (see section Main screen),

- Move the cursor to Menu and press the Enter key (2). Following screen appears:

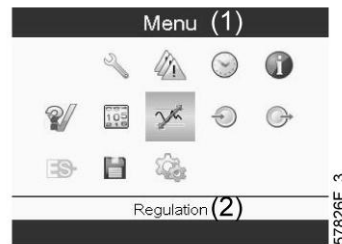

- Using the Scroll keys, select the Settings icon (see section [Modifying general settings](#))
- Press the Enter key. Following screen appears:



- Move the cursor to the Password icon (see above, section Menu icon)
- Select <Modify> using the Scroll keys and press the Enter key. Next, modify the password as required.

## 4.18 Web server

All controllers have a built-in web server that allows direct connection to the company network or to a dedicated PC via a local area network (LAN). This allows to consult certain data and settings via a PC instead of the display of the controller.

### Getting started

Make sure you are logged in as administrator.

- Use the internal network card from your computer or a USB to LAN adapter.
- Use a UTP cable (CAT 5e) to connect to the controller (see picture below).



### Configuration of the network card

- Go to Network and Sharing Center (1).

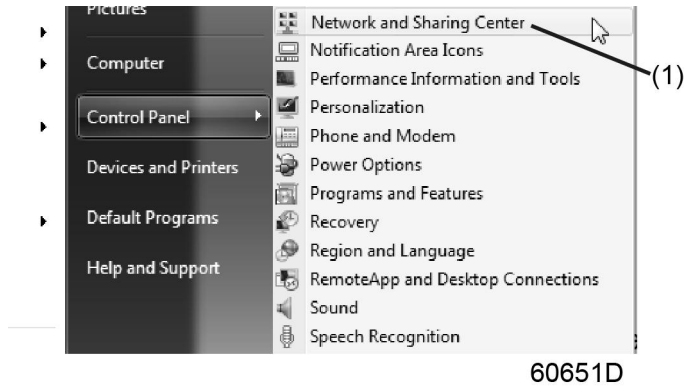

- Click on Change adapter settings (1).

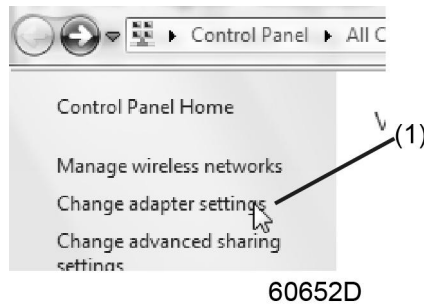

- Select the Local Area Connection, which is connected to the controller.

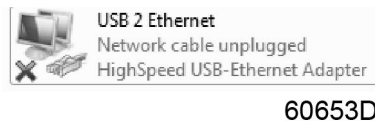

- Click with the right button and select Properties (1).

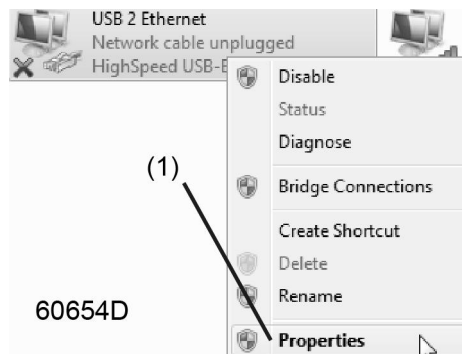

- Use the check box Internet Protocol version +4 (TCP/IPv4) (1) (see picture). To avoid conflicts, uncheck other properties if they are checked. After selecting TCP/IPv4, click on the Properties button (2) to change the settings.

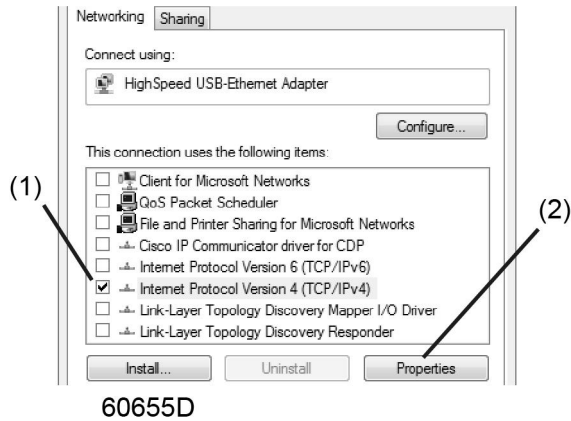

- Use the following settings:
    - IP Address 192.168.100.200 (1)
    - Subnetmask 255.255.255.0 (2)
- Click OK (3) and close network connections.

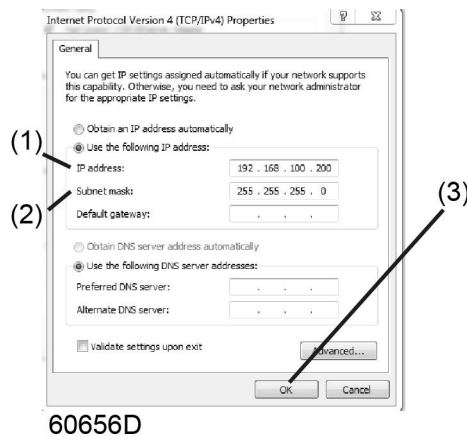

### Configure a company network (LAN) connection

- Ask your IT department to generate a fixed IP address in your company's network.
- That IP address will be excluded from the DNS server, so it will be reserved for the controller.
- Also get the correct Gateway and Subnet mask settings. For example:
  - IP = 10.25.43.200
  - Gateway = 10.25.42.250
  - Subnet mask = 255.255.254.0
- Connect the controller to the company's network (LAN) by using a UTP cable (min. CAT 5e).



- Adapt the network settings in the controller:
  - Go to Main Menu

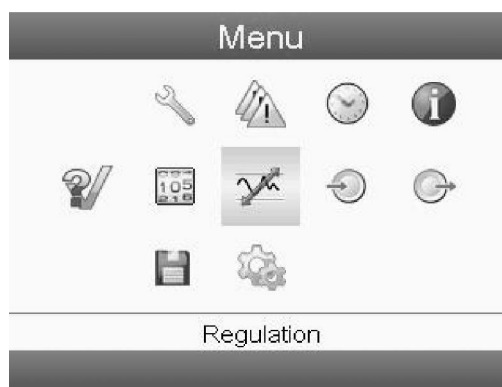

- Go to Settings (1)

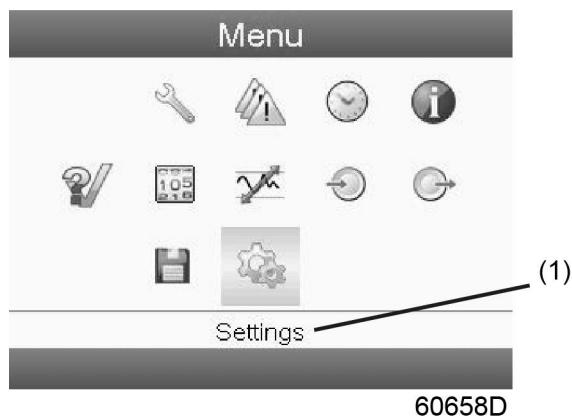

- Go to Network (1)

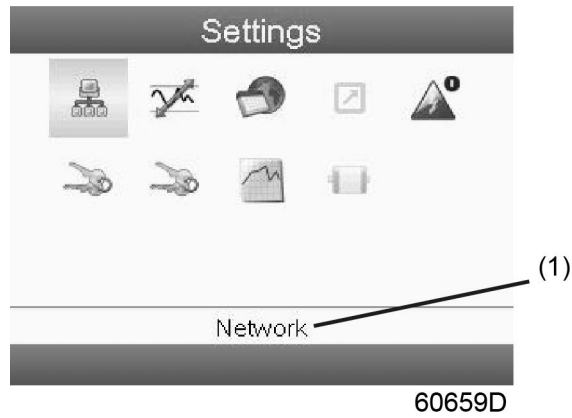

- Go to Ethernet (1)

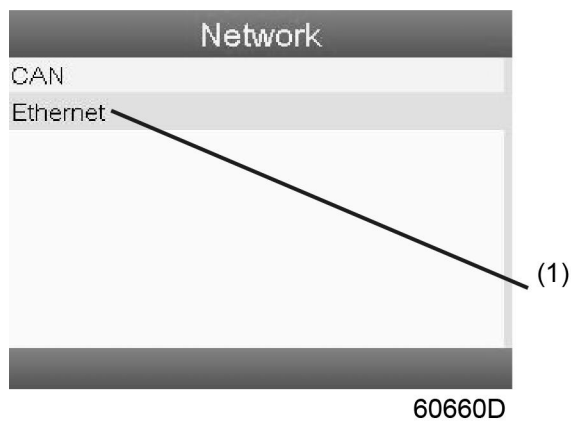

- Switch Off (1) the Ethernet communication to allow editing the settings

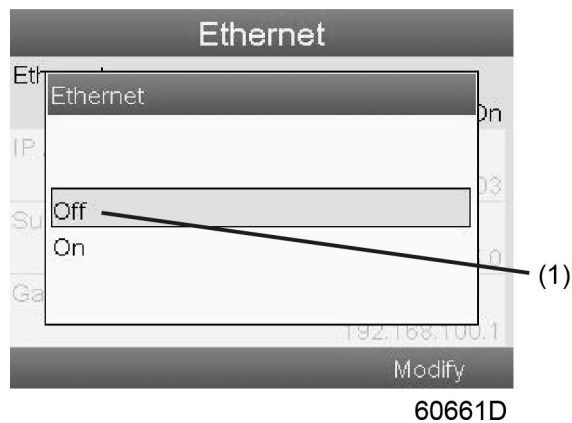

- Adapt IP Address (1)
- Adapt Gateway IP (2)
- Adapt Subnet Mask (3)
- Switch On (4) the Ethernet communication

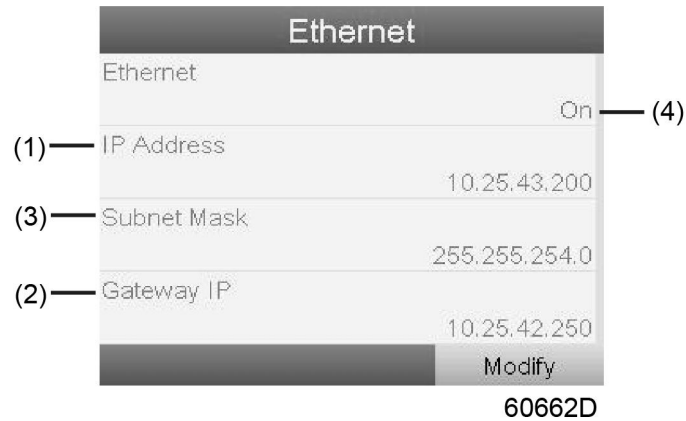

- Wait a few minutes so the LAN network can connect to the controller

### Configuration of the web server

The internal web server is designed and tested for Microsoft® Internet Explorer. Also "Opera", "Mozilla Firefox", "Safari" and "Chrome" should work.

### Viewing the controller data

All screen shots are indicative. The number of displayed fields depends on the selected options.

- Open your browser and type the IP address of the controller you want to view in your browser (in this example <http://192.168.100.100>). The interface opens:

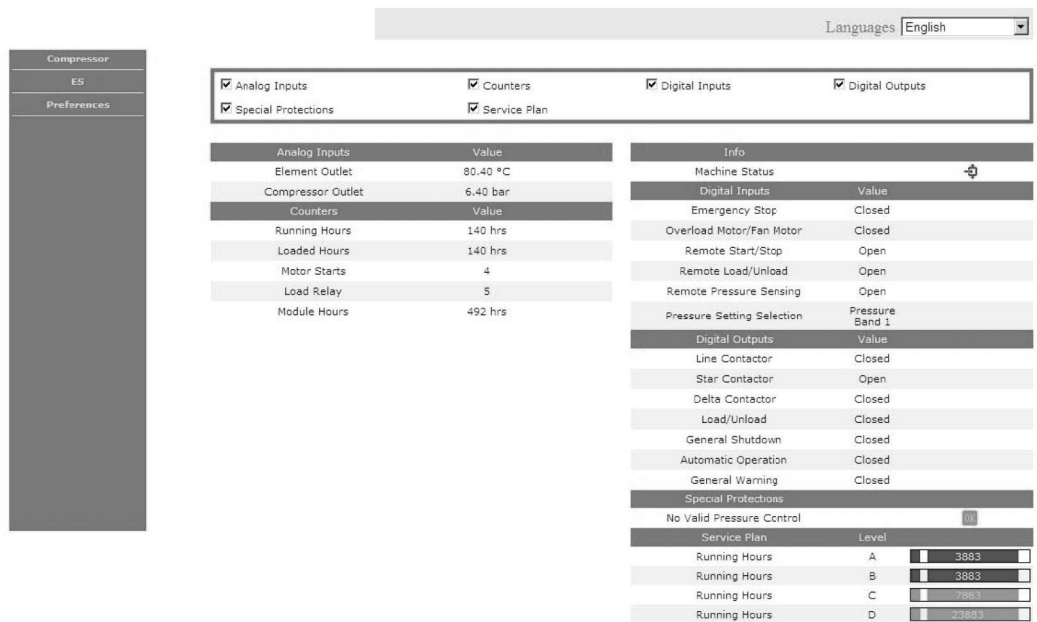

81520D

Screen shot (example!)

### Navigation and options

- The banner shows the unit type and the language selector. In this example, three languages are available on the controller.



81521D

- On the left side of the interface, you can find the navigation menu. If a license for ESi is foreseen, the menu contains 3 buttons.
  - Machine: shows all generator settings.
  - ES: shows the ESi status (if a license is provided).
  - Preferences: allows to change temperature and pressure unit.

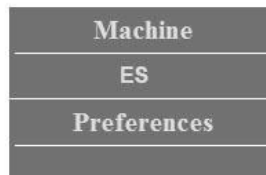

83810D

### Unit settings

All unit settings can be displayed or hidden. Put a check mark in front of each point of interest and it will be displayed. Only the machine status is fixed and can not be removed from the main screen.

#### Analog inputs

Lists all current analog input values. The measurement units can be changed in the preference button from the navigation menu.

Analog Inputs

Analog Inputs	Value
Element Outlet	131.90 °F
Compressor Outlet	110.21 psi

81523D

#### Counters

Lists all current counter values from controller and unit.

Counters

Counters	Value
Running Hours	29 hrs
Loaded Hours	29 hrs
Motor Starts	3
Load Relay	4
Module Hours	549 hrs

81524D

### Info status

Machine status is always shown on the web interface.



### Digital inputs

Lists all digital inputs and their status.

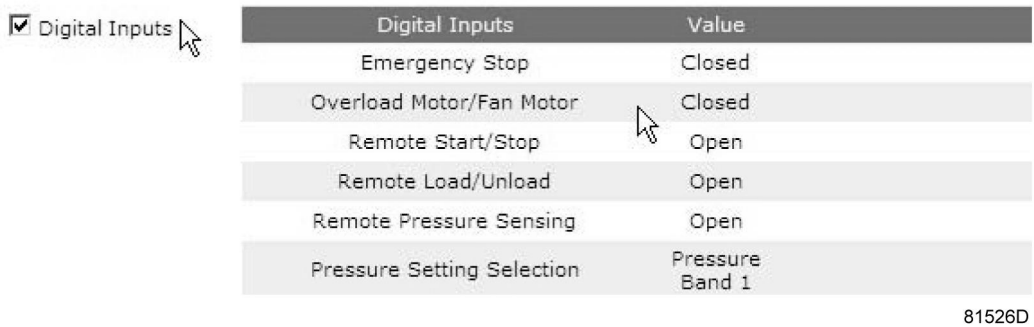

### Digital outputs

Lists all digital outputs and their status.

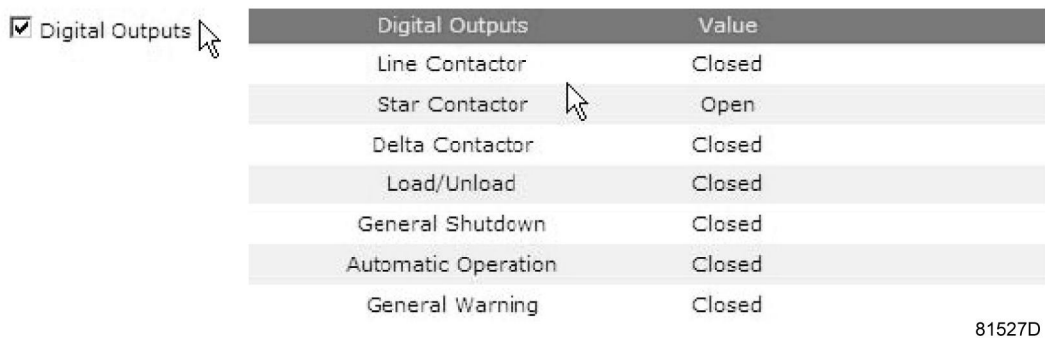

### Special protections

Lists all special protections of the unit.



### Service plan

Displays all levels of the service plan and their status. This screen shot underneath only shows the running hours. It is also possible to show the current status of the service interval.



## 4.19 Programmable settings

### Parameters: unloading/loading pressures for compressors without built-in refrigeration dryer

		Minimum setting	Factory setting	Maximum setting
Unloading pressures				
Unloading pressure (7.5 bar compressors)	bar(e)	4.1	7	7.5
Unloading pressure (7.5 bar compressors)	psig	59.5	101.5	108.8
Unloading pressure (8.5 bar compressors)	bar(e)	4.1	8.0	8.5
Unloading pressure (8.5 bar compressors)	psig	59.5	116.0	123.3
Unloading pressure (10 bar compressors)	bar(e)	4.1	9.5	10
Unloading pressure (10 bar compressors)	psig	59.5	137.8	145.0
Unloading pressure (13 bar compressors)	bar(e)	4.1	12.5	13
Unloading pressure (13 bar compressors)	psig	59.5	181.3	188.6
Unloading pressure (100 psi compressors)	bar(e)	4.1	6.9	7.4
Unloading pressure (100 psi compressors)	psig	59.5	100	107.3
Unloading pressure (125 psi compressors)	bar(e)	4.1	8.6	9.1
Unloading pressure (125 psi compressors)	psig	59.5	125	132
Unloading pressure (150 psi compressors)	bar(e)	4.1	10.3	10.8
Unloading pressure (150 psi compressors)	psig	59.5	150	156.6
Unloading pressure (175 psi compressors)	bar(e)	4.1	12	12.5
Unloading pressure (175 psi compressors)	psig	59.5	175	181.2
Loading pressures				
Loading pressure (7.5 bar compressors)	bar(e)	4	6.4	7.4
Loading pressure (7.5 bar compressors)	psig	58	92.8	107.3
Loading pressure (8.5 bar compressors)	bar(e)	4	7.4	8.4
Loading pressure (8.5 bar compressors)	psig	58	107.3	121.8
Loading pressure (10 bar compressors)	bar(e)	4	8.9	9.9
Loading pressure (10 bar compressors)	psig	58	129.1	143.6
Loading pressure (13 bar compressors)	bar(e)	4	11.9	12.9
Loading pressure (13 bar compressors)	psig	58	172.6	187.1
Loading pressure (100 psi compressors)	bar(e)	4	6.3	7.3
Loading pressure (100 psi compressors)	psig	58	91.4	105.9
Loading pressure (125 psi compressors)	bar(e)	4	8	9

		Minimum setting	Factory setting	Maximum setting
Loading pressure (125 psi compressors)	psig	58	116	130.5
Loading pressure (150 psi compressors)	bar(e)	4	9.7	10.7
Loading pressure (150 psi compressors)	psig	58	140.7	155.2
Loading pressure (175 psi compressors)	bar(e)	4	11.4	12.4
Loading pressure (175 psi compressors)	psig	58	165.3	179.8

**Parameters: unloading/loading pressures for compressors with built-in refrigeration dryer**

		Minimum setting	Factory setting	Maximum setting
Unloading pressures				
Unloading pressure (7.5 bar compressors)	bar(e)	4	7	7.3
Unloading pressure (7.5 bar compressors)	psig	58	101.5	106
Unloading pressure (8.5 bar compressors)	bar(e)	4	8.0	8.3
Unloading pressure (8.5 bar compressors)	psig	58	116	120.5
Unloading pressure (10 bar compressors)	bar(e)	4	9.5	9.8
Unloading pressure (10 bar compressors)	psig	58	137.8	142
Unloading pressure (13 bar compressors)	bar(e)	4	12.5	12.8
Unloading pressure (13 bar compressors)	psig	58	181.3	185.5
Unloading pressure (100 psi compressors)	bar(e)	4	6.9	7.2
Unloading pressure (100 psi compressors)	psig	58	100	104.5
Unloading pressure (125 psi compressors)	bar(e)	4	8.6	8.9
Unloading pressure (125 psi compressors)	psig	58	125	129
Unloading pressure (150 psi compressors)	bar(e)	4	10.3	10.6
Unloading pressure (150 psi compressors)	psig	58	150	153.5
Unloading pressure (175 psi compressors)	bar(e)	4	12	12.3
Unloading pressure (175 psi compressors)	psig	58	175	178.4
Loading pressures				
Loading pressure (7.5 bar compressors)	bar(e)	4	6.4	7.2
Loading pressure (7.5 bar compressors)	psig	58	92.8	104.5
Loading pressure (8.5 bar compressors)	bar(e)	4	7.4	8.2
Loading pressure (8.5 bar compressors)	psig	58	107	119
Loading pressure (10 bar compressors)	bar(e)	4	8.9	9.7
Loading pressure (10 bar compressors)	psig	58	129.1	140.5
Loading pressure (13 bar compressors)	bar(e)	4	11.9	12.7
Loading pressure (13 bar compressors)	psig	58	172.6	184
Loading pressure (100 psi compressors)	bar(e)	4	6.3	7.1
Loading pressure (100 psi compressors)	psig	58	91.4	103
Loading pressure (125 psi compressors)	bar(e)	4	8	8.8
Loading pressure (125 psi compressors)	psig	58	116	127.5
Loading pressure (150 psi compressors)	bar(e)	4	9.7	10.5

		Minimum setting	Factory setting	Maximum setting
Loading pressure (150 psi compressors)	psig	58	140.7	152.5
Loading pressure (175 psi compressors)	bar(e)	4	11.4	12.2
Loading pressure (175 psi compressors)	psig	58	165.3	177

**Parameters**

		Minimum setting	Factory setting	Maximum setting
Motor running time in star	sec	5	10	10
Load delay time (star-delta)	sec	0	0	10
Number of motor starts	starts/day	0	240	240
Minimum stop time	sec	0	20	30
Programmed stop time	sec	0	3	20
Power recovery time (ARAVF)	sec	20	20	3600
Restart delay	sec	0	0	1200
Communication time-out	sec	10	30	60

**Protections**

		Minimum setting	Factory setting	Maximum setting
Compressor element outlet temperature (shut-down warning level)	°C	50	110	119
Compressor element outlet temperature (shut-down warning level)	°F	122	230	246
Compressor element outlet temperature (shut-down level)	°C	111	120	120
Compressor element outlet temperature (shut-down level)	°F	232	248	248

**Service plan**

The built-in service timers will give a Service warning message after their respective preprogrammed time interval has elapsed.

Also see section Preventive maintenance schedule.

Consult Atlas Copco if a timer setting has to be changed. The intervals must not exceed the nominal intervals and must coincide logically. See section [Modifying general settings](#).

**Terminology**

Term	Explanation
ARAVF	Automatic Restart After Voltage Failure. See section <a href="#">Elektronikon regulator</a> .

<b>Term</b>	<b>Explanation</b>
Power recovery time	Is the period within which the voltage must be restored to have an automatic restart. Is accessible if the automatic restart is activated. To activate the automatic restart function, consult Atlas Copco.
Restart delay	This parameter allows to programme that not all compressors are restarted at the same time after a power failure (ARAVF active).
Compressor element outlet	The recommended minimum setting is 70 °C (158 °F). For testing the temperature sensor the setting can be decreased to 50 °C (122 °F). Reset the value after testing. The regulator does not accept illogical settings, e.g. if the warning level is programmed at 95 °C (203 °F), the minimum limit for the shut-down level changes to 96 °C (204 °F). The recommended difference between the warning level and shut-down level is 10 °C (18 °F).
Delay at shut-down signal	Is the time for which the signal must exist before the compressor is shut down. If it is required to program this setting to another value, consult Atlas Copco.
Oil separator	Use only Atlas Copco oil separators. The recommended maximum pressure drop over the oil separator element is 1 bar (15 psi).
Minimum stop time	Once the compressor has automatically stopped, it will remain stopped for the minimum stop time, whatever happens with the net air pressure. Consult Atlas Copco if a setting lower than 20 seconds is required.
Unloading/ Loading pressure	The regulator does not accept inconsistent settings, e.g. if the unloading pressure is programmed at 7.0 bar(e) (101 psi(g)), the maximum limit for the loading pressure changes to 6.9 bar(e) (100 psi(g)). The recommended minimum pressure difference between loading and unloading is 0.6 bar (9 psi(g)).

## 5 Energy recovery (optional)

### 5.1 Energy recovery unit

#### Description

A large part of the energy required for any compression process is transformed into heat. For oil-injected screw compressors, the major part of the compression heat is dissipated through the oil system. The energy recovery (ER) systems are designed to recover most of this heat by transforming it into warm or hot water without any adverse influence on the compressor performance. The water can be used for diverse applications.

#### Components

The energy recovery system is completely integrated and mainly comprises:

- Stainless steel oil/water heat exchanger
- Thermostatic by-pass valve for energy recovery heat exchanger(s) (BV2)
- Two temperature sensors for water inlet and outlet control (3 and 4)
- The necessary bolts, flexibles, etc.
- Oil drain plug.

#### Energy recovery unit (ER-unit)

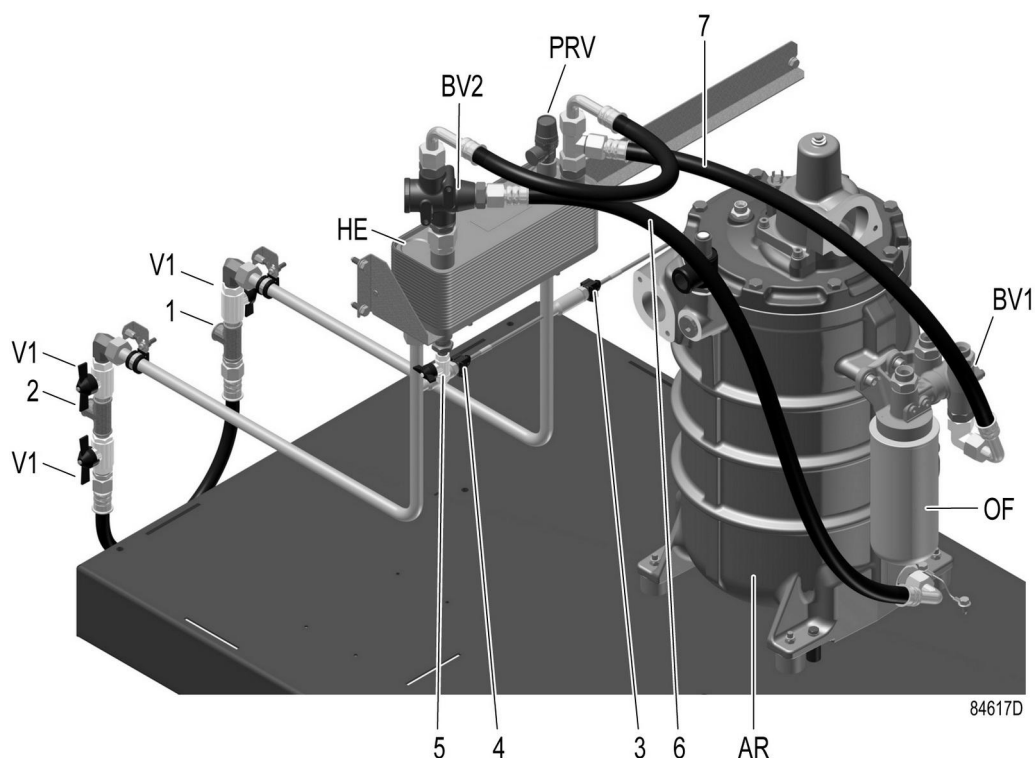

Main components of the ER unit

Reference	Designation
1	Water inlet pipe
2	Water outlet pipe
3	Temperature sensor, water inlet pipe
4	Temperature sensor, water outlet pipe
5	Oil drain plug
6	Oil flexible from compressor oil separator vessel to ER unit
7	Oil flexible from ER unit to oil filter housing
PRV	Pressure relief valve
BV2	Location of heat exchanger by-pass valve (BV2)
HE	Heat exchanger
V1	Selector valve
AR	Oil separator tank
OF	Oil filter housing
BV1	Location of oil cooler bypass valve (BV1)

### Field installation

The main components are assembled ex-factory as a compact unit which fits inside the bodywork of the compressor. Consult your dealer for installing and connecting the energy recovery unit.

## 5.2 Energy recovery systems

### General

The energy recovery systems can be applied as low temperature rise/high water flow systems or as high temperature rise/low water flow systems.

#### Low temperature rise/high water flow systems

For this type of application, the temperature difference between the water in the energy recovery system and the compressor oil is low. As a consequence, a high water flow is needed for maximum energy recovery.

Example: The heated water is used to keep another medium at a moderately high temperature, in a closed circuit, e.g. central heating.

#### High temperature rise/low water flow systems

For this type of application, a high water temperature rise in the energy recovery system is obtained, which consequently brings on a low flow rate.

Example: An open circuit where cold water from a main supply is heated by the energy recovery system for use in a factory, e.g. pre-heating of boiler feed water.

### Recovery water flow

For the references, see section [Energy recovery data](#).

The recovery water enters the unit at inlet connection (1). In heat exchanger (HE) the compression heat is transferred from the compressor oil to the water. The water leaves heat exchanger (HE) via outlet connection (2).

### Water requirements for closed water circuits

The use of a closed water circuit minimises make-up water requirements. Therefore, the use of soft or even demineralised water is economically feasible and eliminates the problem of scale deposits. Although the heat exchanger is made of stainless steel, the water circuit connected to the compressor may require corrosion inhibitors.

Consult section [Cooling water requirements](#) to minimise problems due to bad water quality. If in any doubt, consult Atlas Copco.

Add an anti-freeze product such as ethylene-glycol to the water in proportion to the expected temperature to avoid freezing.

### Water requirements for open water circuits

For open, non-recirculation water circuits, the major problems usually encountered are related to deposit control, corrosion control and microbiological growth control. To minimize these problems, the water should meet a number of requirements.

See section [Cooling water requirements](#). If in any doubt, consult Atlas Copco.

## 5.3 Operation

### Description

The compressor oil flow is controlled by two thermostatic valves (BV1 and BV2), ensuring reliable compressor operation and optimal energy recovery.

Bypass valve (BV1) is integrated in the oil filter housing of the compressor and controls the oil flow through the main oil cooler (C0) of the compressor. Bypass valve (BV2) controls the oil flow through the oil/water heat exchanger (HE) of the ER unit. Both valves consist of an insert (thermostat) mounted in a housing.

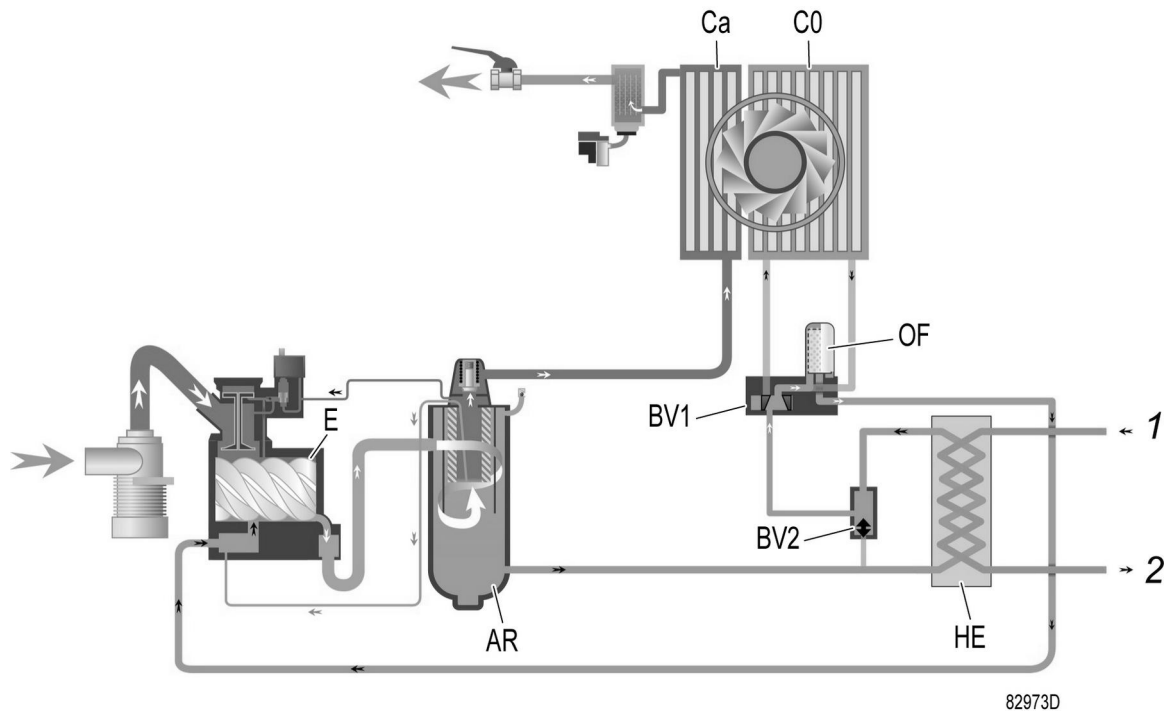

Flow diagram of compressor with energy recovery system

Reference	Designation	Reference	Designation
BV2	Thermostatic bypass valve of ER unit	OF	Oil filter
HE	Oil/water heat exchanger (ER unit)	AR	Oil separator tank
E	Compressor element	BV1	Thermostatic bypass valve in oil filter housing
C0	Oil cooler (compressor)	Ca	Aftercooler (compressor)
1	Water inlet	2	Water outlet

BV2 starts closing the bypass line over the heat exchanger (HE) at the lower limit of its temperature range. At the upper limit of its temperature range, the bypass line is completely closed and all the oil flows through the ER heat exchanger.

On compressors versions with a maximum pressure lower than 13 bar (175 psi), BV2 starts opening at 40 °C (104 °F) and is completely open at 55 °C (131 °F).

On compressors with a maximal pressure of 13 bar (175 psi), BV2 starts opening at 60 °C (140 °F) and is completely open at 75 °C (167 °F).

The oil cooler bypass valve (BV1) starts closing the bypass over the oil cooler (C0) at the lower limit of its temperature range. At the upper limit of its temperature range, the bypass is completely closed and all the oil flows through the oil cooler (C0).

BV1 must have a higher opening temperature (set point) than BV2 in order to prevent the heat from being dissipated in the compressor oil cooler (C0) rather than in the oil/water heat exchanger (HE) when using the compression heat as source for energy recovery. Thermostat BV1 starts to open at 75 °C (167 °F) and is completely open at 90 °C (194 °F).

## Energy recovery system in use (see drawing)

### Compressor start-up

When the compressor is started up from cold, the oil temperature will be low. Bypass valve (BV2) shuts off the oil supply through the heat exchanger (HE) and bypass valve (BV1) shuts off the oil supply through the oil cooler (C0) to prevent the compressor oil from being cooled. The oil flows from the oil separator tank (AR) through the oil filter(s) (OF) back to compressor element (E).

All energy input is used to rapidly warm up the compressor oil. No energy is recovered.

### Maximum energy recovery

As soon as the oil temperature reaches the setpoint (opening temperature) of bypass valve (BV2), the valve starts closing off the bypass over the heat exchanger (HE) oil flexible, gradually allowing the oil to flow through the heat exchanger (HE). As the oil temperature rises to approx. 15 °C (27 °F) above the setpoint, all the oil passes through the heat exchanger. The exchange of heat between the compressor oil and the heat recovery water is maximum. The oil from the heat exchanger outlet flows via oil filter (OF), compressor element (E) and separator (AR) back to the inlet of heat exchanger (HE). Bypass valve (BV1) bypasses the oil cooler (C0) as long as the oil temperature remains below its setpoint.

Operation principle at different loads:

- Low consumption of recovered energy  
The temperature of the oil leaving heat exchanger (HE) rises. When the temperature rises above its set point, oil cooler bypass valve (BV1) will gradually allow the oil to be cooled in the oil cooler (Co).
- Recovery water flow too high/temperature too low  
In this case, bypass valve (BV2) will open the bypass line allowing oil from heat exchanger (HE) to be mixed with oil from separator (AR). Energy is transferred from the compressor oil to the water, but at a relatively low temperature level.

## Energy recovery system not in use

The oil circuit is the same as without installation of the energy recovery system.

No energy is recovered.

This situation should be considered as exceptional, e.g. in case of maintenance of the energy recovery system or when no energy is required for a long period.

Run the unit unloaded for a few minutes before isolating the energy recovery system from the compressor.

## Stopping the unit for a long period

In case of an open water system and/or if freezing temperatures can be expected, isolate the compressor water system and blow it through with compressed air.

# 5.4 Maintenance

## Compressor oil

For references used, consult section Energy recovery.

### Oil change:

1. Run the unit until warm. Stop the unit, switch off the isolating switch and close the air outlet valve of the compressor.
2. Depressurize the compressor and drain the oil by opening the drain valve on the oil separator vessel. See section Oil and oil filter change.
3. Resume oil change as described in section Oil and Filter Change in this book.  
Units with the energy recovery option are factory filled with 8000 h oil.  
The oil should be changed every 4000 h because the oil temperature is higher in units with energy recovery.

**Thermostatic bypass valves**

The inserts (thermostats) must be replaced by new ones when abnormal function is noticed. Examples: regulating temperature is not within the normal range, ER heat exchanger remains cold,...

**Heat exchanger (HE)**

If the temperature rise over the energy recovery system declines over a period of time with the same basic working conditions, the heat exchanger should be inspected. To clean the oil side, soak the heat exchanger in a degreasing solution. To remove scale formation in the water compartment, a proper descaling process should be applied. Consult your customer centre.

## 5.5 Energy recovery data

**Reference conditions**

See section [Reference conditions and limitations](#).

**Effective working pressure**

Consult section Compressor data for the normal working pressure.

**Maximum allowed pressure of the heat exchanger**

Oil side	15 bar (217 psi)
Water side	10 bar (145 psi)

**Reading settings**

**In addition to other data, the following temperatures can be read on the controller display:**

- The water inlet temperature of the energy recovery system
- The water outlet temperature of the energy recovery system

**Modifying settings**

If the programmed warning settings for the water temperatures are exceeded, a warning indication is shown on the controller:

Temperature input		Minimum setting	Nominal setting	Maximum setting
Water inlet temperature of energy recovery	°C	0	50	99
Water inlet temperature of energy recovery	°F	32	122	210
Energy recovery water outlet temperature	°C	0	Depends on application	99
Energy recovery water outlet temperature	°F	32	Depends on application	210

To modify a setting, consult the relevant section in the description of the controller.

### Recoverable energy

The recoverable energy can be calculated from:

$$\text{RECOVERED ENERGY (kW)} = 4.2 \times \text{water flow (l/s)} \times \text{water temperature rise (°C)}$$

In the tables below, typical examples are given.

### Data for low temperature rise/low water flow systems

Parameter	Unit	GA 30+	GA 37	GA 45
Recoverable energy	kW	27.5	32.5	39.5
Recoverable energy	hp	36.8	43.5	53
Water flow	l/min	39.4	46.6	56.6
Water flow	cfm	1.4	1.6	2
Temperature at inlet	°C	50	50	50
Temperature at inlet	°F	122	122	122
Temperature at outlet	°C	60	60	60
Temperature at outlet	°F	140	140	140

### Data for high temperature rise/low water flow systems

Parameter	Unit	GA 30+	GA37	GA 45
Recoverable energy	kW	27.5	32.5	39.5
Recoverable energy	hp	36.8	43.5	53
Water flow	l/min	5.5	6.5	7.9
Water flow	cfm	0.19	0.23	0.28
Temperature at inlet	°C	20	20	20
Temperature at inlet	°F	68	68	68
Temperature at outlet	°C	92	92	92
Temperature at outlet	°F	197	197	197

## 5.6 Cooling water requirements

### General

	<p>Cooling water needs to fulfill certain requirements in order to avoid problems of scaling, fouling, corrosion or bacterial growth.</p> <p>In open circuit cooling towers, protective measures must be taken to avoid the growth of harmful bacteria such as legionella pneumophila when there is a risk of inhalation of the water droplets.</p>
---	---

No general recommendation can encompass the effects of all combinations of the various compounds, solids and gases typically found in cooling water in interaction with different materials. Therefore the recommendations formulated in our Cooling Water Specifications are a general guide line for acceptable coolant quality. However, where strict limits apply, a statement is made in the specification.

The water requirements refer to untreated water. When water is treated, some parameters will change. Water treatments should be carried out by a specialized water treatment company, taking the responsibility for the performance of the treated cooling water and the compatibility with the materials in the cooling circuit. This includes not only the selection of the appropriate additives, but also the correct application, monitoring of concentrations and properties, prevention of sludge formation and maintenance of the system. This applies also to treatment with antifreeze products. They must be provided with suitable stabilizers and inhibitors. Specifications are also depending on the type of cooling circuit (open, once through / recirculating with tower / closed) and on the application (Standard – max 65 °C cooling water temperature at the outlet) or Energy Recovery (water temperature up to 95 °C).

In case water is not in line with recommended values or if any doubt, consult the manufacturer.

### Cooling water parameters

#### 1. pH

The effect of pH is already included in the Ryznar Stability Index (RSI - see item 4 below), but also the pH itself is subject to limitations:

Type of cooling system	Materials	pH	
		Standard	Energy recovery
Single pass	Containing copper	<b>6.8 - 9.3</b>	<b>6.8 - 9.3</b>
	Stainless steel with carbon steel and / or cast iron	<b>6.8 - 9.3</b>	<b>6.8 - 9.3</b>
	Stainless steel only	<b>6 - 9.3</b>	<b>6 - 9.3</b>
Recirculating (with tower)	Containing copper	<b>6.8 - 9.3</b>	not applicable
	Stainless steel with carbon steel and / or cast iron	<b>6.8 - 9.3</b>	
	Stainless steel only	<b>6 - 9.3</b>	
Closed loop	Containing copper	<b>7.5 - 9.3</b>	<b>7.5 - 9.3</b>
	Stainless steel with carbon steel and / or cast iron	<b>7.5 - 9.3</b>	<b>7.5 - 9.3</b>
	Stainless steel only	<b>6 - 9.3</b>	<b>6 - 9.3</b>

The values in **bold** are rejection limits.

When the system contains Zn or Al, the pH must be < 8.5.

## 2. Total dissolved solids (TDS) and conductivity

The conductivity is expressed in  $\mu\text{S}/\text{cm}$ , the TDS in ppm.

Both parameters are related with each other. The conductivity is convenient for quick monitoring of general water quality, but the TDS is required for calculating the RSI. If only one of both parameters is measured, an estimation can be obtained by using a theoretical conversion factor (0.67):

$$\text{TDS} = \text{conductivity} \times 0.67$$

## 3. Hardness

Different types of hardness are in relation with each other and together with the pH and the alkalinity of the water they determine the equilibrium situation of the water, determined and specified by the RSI.

In addition, the calcium hardness must be limited to:

Type of cooling system	Ca (ppm Ca CO <sub>3</sub> )	
	Standard	Energy recovery
Single pass	< 500	< 2
Recirculating (with tower)	< 500	not applicable
Closed loop	< 1000	< 50

## 4. The Ryznar Stability Index (RSI)

The Ryznar Stability Index is a parameter for predicting whether water will tend to dissolve or precipitate calcium carbonate. The adhesion of scaling depositions and their effect are different on different materials, but the equilibrium of the water (scaling or corrosive) is only determined by its actual pH value and by the saturation pH value ( $\text{pH}_s$ ). The saturation pH value is determined by the relationship between the calcium hardness, the total alkalinity, the total solids concentration and the temperature.

The Ryznar Stability Index is calculated as follows:

$$\text{RSI} = 2 \cdot \text{pH}_s - \text{pH},$$

in which

- pH = measured pH (at room temp) of the water sample
- $\text{pH}_s$  = pH at saturation

$\text{pH}_s$  is calculated from:

$$\text{pH}_s = (9.3 + A + B) - (C + D),$$

in which

- A : depends on the total solids concentration
- B : depends on the water temperature at the outlet of the heat exchanger
- C : depends on the calcium hardness (CaCO<sub>3</sub>)
- D : depends on the HCO<sub>3</sub><sup>-</sup> concentration or M-alkalinity

The values of A, B, C and D can be found in below table:

Total dissolved solids (mg/l)	A	Temperature (°C)	B	Ca hardness (ppm CaCO <sub>3</sub> )	C	M-Alkalinity (ppm CaCO <sub>3</sub> )	D
< 30	0.1	0 - 1	2.3	9 - 11	0.6	10 - 11	1.0
30 - 320	0.2	2 - 6	2.2	12 - 14	0.7	12 - 14	1.1
> 320	0.3	7 - 11	2.1	15 - 17	0.8	15 - 17	1.2

Total dissolved solids (mg/l)	A	Temperature (°C)	B	Ca hardness (ppm CaCO <sub>3</sub> )	C	M-Alkalinity (ppm CaCO <sub>3</sub> )	D
		12 - 16	2.0	18 - 22	0.9	18 - 22	1.3
		17 - 22	1.9	23 - 28	1.0	23 - 28	1.4
		23 - 27	1.8	29 - 35	1.1	29 - 35	1.5
		28 - 32	1.7	36 - 44	1.2	36 - 44	1.6
		33 - 38	1.6	45 - 56	1.3	45 - 56	1.7
		39 - 43	1.5	57 - 70	1.4	57 - 70	1.8
		44 - 49	1.4	71 - 89	1.5	71 - 89	1.9
		50 - 55	1.3	90 - 112	1.6	90 - 112	2.0
		56 - 61	1.2	113 - 141	1.7	113 - 141	2.1
		62 - 67	1.1	142 - 177	1.8	142 - 177	2.2
		68 - 73	1.0	178 - 223	1.9	178 - 223	2.3
		74 - 79	0.9	224 - 281	2.0	224 - 281	2.4
		80 - 85	0.8	282 - 355	2.1	282 - 355	2.5
		86 - 91	0.7	356 - 446	2.2	356 - 446	2.6
		92 - 95	0.6	447 - 563	2.3	447 - 563	2.7
				564 - 707	2.4	564 - 707	2.8
				708 - 892	2.5	708 - 892	2.9
				893 - 1000	2.6	893 - 1000	3.0

**Interpretation of the values obtained:**

- RSI < 6: boiler scale formation
- 6 < RSI < 7: neutral water
- RSI > 7: corrosive water



As a general rule, the RSI index should be between 5.6 and 7.5. If that is not the case, contact a specialist.

**5. Free chlorine (Cl<sub>2</sub>)**

Disinfecting with chlorine is **not done in closed systems, neither in energy recovery systems.**

A continuous level of 0.5 ppm should not be exceeded. For shock treatments, a maximum limit of 2 ppm for maximum 30 minutes/day applies.

**6. Chlorides (Cl<sup>-</sup>)**

Chloride ions will create pitting corrosion on stainless steel. Their concentration should be limited, depending from the RSI value.

	RSI < 5.5	5.6 < RSI < 6.2	6.3 < RSI < 6.8	6.9 < RSI < 7.5	7.6 < RSI
Cl <sup>-</sup> (ppm)	200	350	500	350	200

**For energy recovery systems, the limit is 100 ppm.**

**7. Sulphates (SO<sub>4</sub><sup>2-</sup>)**

Type of cooling system	Sulphate (ppm)	
	Standard	Energy recovery
Single pass	< 1000	< 200
Recirculating (with tower)	< 1000	not applicable
Closed loop	< 400	< 200

## 8. Iron and Manganese

Type of cooling system	Dissolved iron (ppm)		Dissolved manganese (ppm)	
	Standard	Energy recovery	Standard	Energy recovery
Single pass	< 1	< 0.2	< 0.2	< 0.05
Recirculating (with tower)	< 1	not applicable	< <b>0.2</b>	not applicable
Closed loop	< 1	< 0.2	< 0.2	< 0.05

The values in **bold** are rejection limits.

## 9. Copper

Type of cooling system	Copper (ppm)	
	Standard	Energy recovery
Single pass	< 1	< 0.2
Recirculating (with tower)	< 1	not applicable
Closed loop	< 1	< 0.2

## 10. Ammonium

The limit of **0.5 ppm** is a rejection limit.

The limitation only applies for copper containing systems.

## 11. Suspended solids

Large particles (size > 10 µm) should not be present as they can be filtered out.

Small particles (< 0.5 µm) are not taken into account.

For particles between 0.5 µm and 10 µm, the following limits apply:

Type of cooling system	Suspended solids (ppm)	
	Standard	Energy recovery
Single pass	< 10	< 1
Recirculating (with tower)	< 10	not applicable
Closed loop	< 10	< 1

## 12. Oil or grease

< **1 ppm** (rejection value)

## 13. Biology

If biology is present, it must be aerobic. Anaerobic biology (in closed systems) must be avoided.

Type of cooling system	Biology (CFU/ml)	
	Standard	Energy recovery
Single pass	< 10 <sup>5</sup> / < <b>10<sup>7</sup></b>	< 10 <sup>3</sup> / < <b>10<sup>5</sup></b>
Recirculating (with tower)	< 10 <sup>5</sup> / < <b>10<sup>7</sup></b>	not applicable
Closed loop	< 10 <sup>3</sup> / < <b>10<sup>5</sup></b>	< 10 <sup>3</sup> / < <b>10<sup>5</sup></b>

The table shows the recommended values. The values in **bold** are rejection limits.

	<p>If additives are used in the cooling water, take into account that the cooling capacity will change.</p> $\Delta m = ((C_{pw} - C_{pa}) * X) / (C_{pw} * (1-X) + X * C_{pa}) * 100 \%$ <p>with</p> <p><math>\Delta m</math>: change of mass flow of the coolant  <math>C_{pw}</math>: specific heat capacity of water  <math>C_{pa}</math>: specific heat capacity of the additives  <math>X</math>: the percentage of additives</p>
---	---

## 6 Installation

### 6.1 Dimension drawings

The dimension drawing can be found on the CD-ROM, DVD or USB, supplied with the unit.

Dimension drawing	Model
9828 5102 34-01	GA 30 <sup>+</sup> , GA 37, GA 45 Pack, metric units
9828 5102 34-02	GA 30 <sup>+</sup> , GA 37, GA 45 Pack, imperial units
9828 5102 35-01	GA 30 <sup>+</sup> , GA 37, GA 45 Full Feature, metric units
9828 5102 35-02	GA 30 <sup>+</sup> , GA 37, GA 45 Full Feature, imperial units

Text on drawings	Translation or Explanation
Cooling air outlet of compressor	Cooling air outlet of compressor and motor
Air inlet of compressor	Cooling air inlet of compressor and motor
Compressed air outlet	Compressed air outlet connection
Electrical cable passage	Electrical cable passage
Cooling air outlet of cubicle	Cubicle cooling air outlet
Doors fully open	Dimensions with doors fully open
Cooling air inlet of dryer	Dryer cooling air inlet
Cooling air outlet of dryer	Dryer cooling air outlet
Centre of gravity	Centre of gravity
Approx. mass	Approximate mass of the machine
Manual drain of after cooler	Manual drain, aftercooler
Automatic drain of after cooler	Connection of the automatic drain of the aftercooler
Manual drain of dryer	Manual drain of the dryer
Automatic drain of dryer	Connection of the automatic drain of the dryer
Only for energy recovery option	Only for energy recovery option
Water inlet (energy recovery)	Water inlet (energy recovery option)
Water outlet (energy recovery)	Water outlet (energy recovery option)
Mounting holes of compressor	Mounting holes to fixate the compressor

### 6.2 Installation proposal

#### Safety

	The operator must apply all relevant safety precautions, including those mentioned in this book.
---	--

## Outdoor/altitude operation

	<p>The compressor is not designed for installation outdoors. The compressors can be sold with option <u>rain protection</u>. With this option, this compressor can be installed outside under a shelter, in frost free conditions. If frost might occur, the appropriate measures must be taken to avoid damage to the machine and its ancillary equipment. Consult Atlas Copco.</p>
---	--

## Moving/lifting

	<p>The compressor can be moved by a lift truck using the slots in the frame. Take care not to damage the bodywork during lifting or transport. Make sure that the forks protrude from the other side of the frame. The compressor can also be lifted after inserting beams in the slots. Make sure that the beams cannot slide and that they protrude from the frame equally. The chains must be held parallel to the bodywork by chain spreaders in order not to damage the compressor. The lifting equipment must be placed in such a way that the compressor is lifted perpendicularly. Lift gently and avoid twisting.</p>
---	--

	<p>In case of units equipped with the Lifting Device Option, it is not allowed to lift the compressor if the canopy parts or lifting supports are not completely installed. When the compressor is being lifted, it is also forbidden to come under the load or to perform maintenance activities to it.</p>
---	--

### Compressor room example

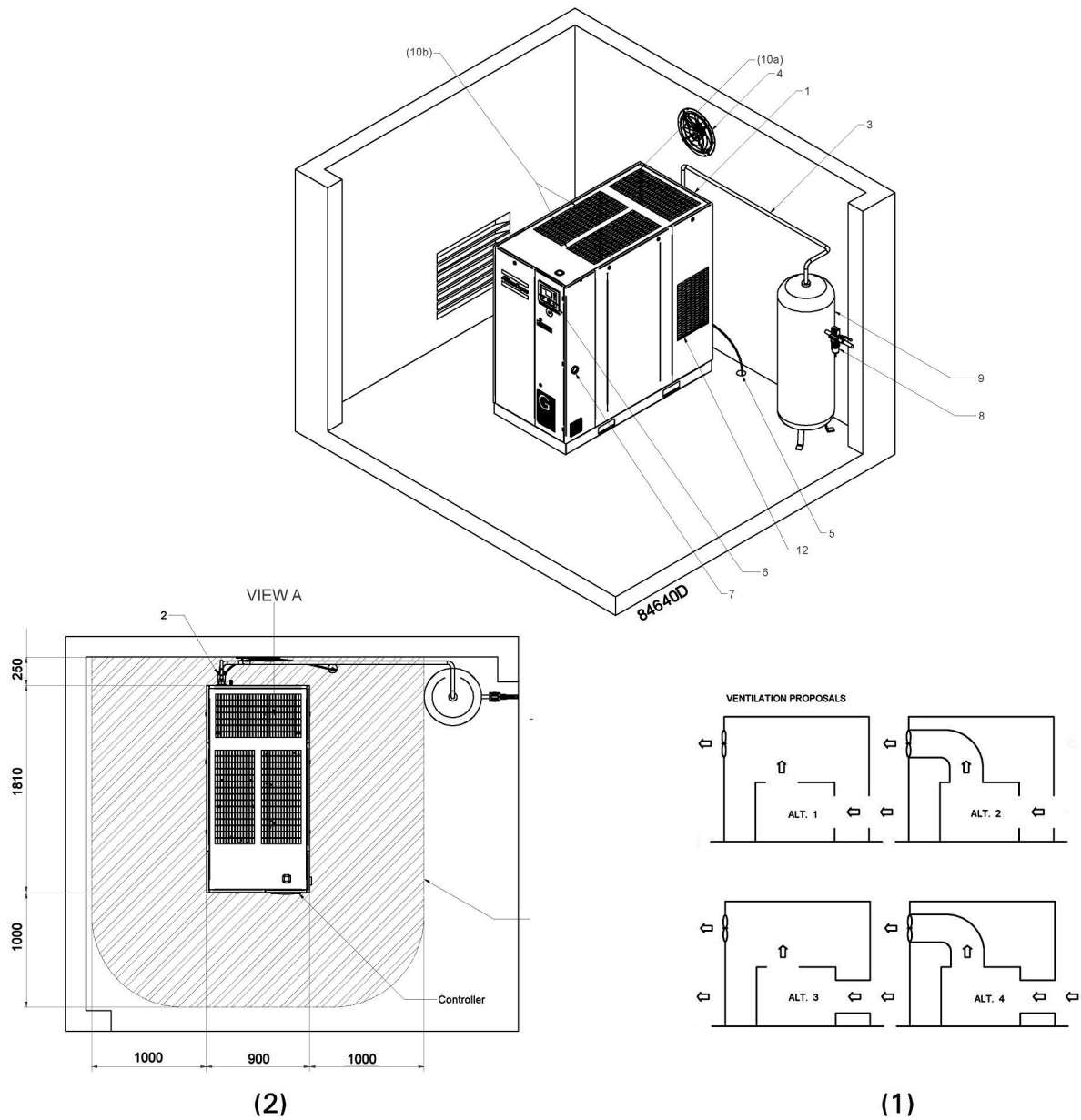

Text on drawing

Reference	Designation
(1)	Ventilation proposals
(2)	Minimum free area to be reserved for the compressor installation

	All piping to be connected stress free to the compressor.
--	---

### Installation guidelines

1. Install the compressor unit on a solid, level floor suitable for taking its weight.

2. Position of the compressed air outlet valve.
3. The pressure drop over the air delivery pipe can be calculated from:

$$\Delta p = (L \times 450 \times Q_c^{1.85}) / (d^5 \times P), \text{ with}$$

- $\Delta p$  = pressure drop in bar (recommended maximum: 0.1 bar (1.5 psi))
- L = length of the pipe in m
- $Q_c$  = Free air delivery of the compressor in l/s
- d = inner diameter of the pipe in mm
- P = absolute pressure at the compressor outlet in bar(a)

It is recommended that the connection of the compressor air outlet pipe is made on top of the main air net pipe in order to minimise carry-over of possible condensate residue.

4. Ventilation: the inlet grids and ventilation fan should be installed in such a way that any re-circulation of cooling air is avoided.

The maximum air velocity through the grids is 5 m/s (16.5 ft/s).

The maximum air temperature at the compressor intake is 46 °C (115 °F), the minimum air temperature is 0 °C (32 °F).

**The required ventilation capacity to limit the compressor room temperature can be calculated as follows:**

$$Q_v = 1.06 N/\Delta T \text{ for versions without dryer}$$

$$Q_v = (1.06 N + 1.3)/\Delta T \text{ for versions with dryer}$$

- $Q_v$  = Required ventilation capacity in m<sup>3</sup>/s
  - N = Shaft input of compressor in kW
  - $\Delta T$  = Temperature increase in the compressor room in °C
5. The drain pipes to the drain collector must not dip into the water of the drain collector. Any flow back must be avoided. Oil/water separators to separate the major part of the oil from the condensate to ensure that the condensate meets the requirements of the environmental codes are available.
  6. Control module with monitoring panel.
  7. Position of the main cable entry. Power supply cable to be sized and installed by a qualified electrician.



To preserve the protection degree of the electric cubicle and to protect its components from dust from the environment, it is mandatory to use a proper cable gland when connecting the supply cable to the compressor.

8. Provision for inlet and outlet of the energy recovery system (system is optional).
9. The air receiver (optional) should be installed in a frost-free room on a solid, level floor for normal air consumption, the volume of the air net (receiver and piping) can be calculated as follows:

$$V=(0.25 \times Q_c \times P_1 \times T_o)/(f_{max} \times \Delta P \times T_1)$$

- V= Volume of the air net in l.
- $Q_c$ = Free air delivery of the compressor in l/s
- $P_1$ = Compressor air inlet pressure in bar absolute
- $f_{max}$ = Cycle frequency =1 cycle/30s
- $\Delta P$ = P unload - P load in bar
- $T_1$ = Compressor air inlet temperature in K

- To= Air receiver temperature K
10. To prevent feedback of exhaust air to the cooling inlet, sufficient space should be foreseen above the unit to evacuate the exhaust air.

## 6.3 Electrical connections

### Important remark



To preserve the protection degree of the electric cubicle and to protect its components from dust from the environment, it is mandatory to use a proper cable gland when connecting the supply cable to the compressor.

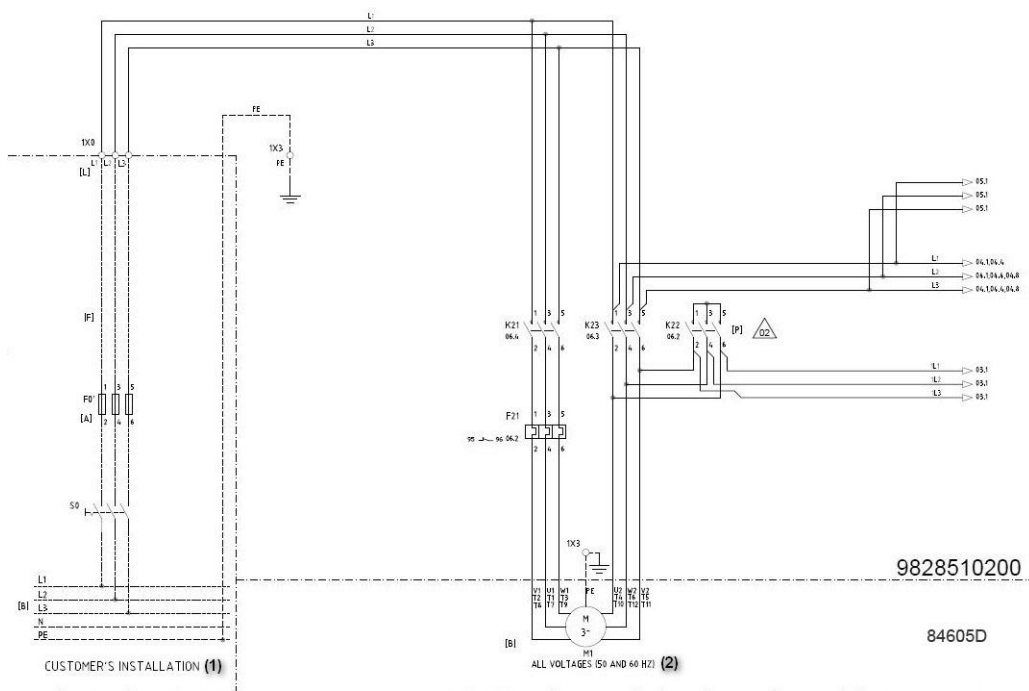

Electrical connections

Reference	Designation
(1)	Customer's installation
(2)	All voltages (50 and 60 Hz)

### Instructions

1. Provide an isolating switch.
2. Check that the motor cables and wires inside the electric cabinet are clamped tight to their terminals.
3. Check the fuses and the setting of the overload relay. See section [Electrical cable size](#).
4. Connect earth conductor bolt (PE).
5. Connect the power supply cables to their terminals L1, L2, L3.

### Compressor status indication

On compressors equipped with an Elektronikon™ controller, the controller is provided with an auxiliary relay (K05) for remote indication of a shutdown. This NO contact (NO = normally open) will be closed if all conditions are normal and will open in case of power failure or shutdown.

Maximum contact load: 10 A / 250 V AC.

On compressors equipped with an Elektronikon™ Graphic controller, the controller is provided with potential free auxiliary NO contacts (NO = normally open) (K05, K07 and K08) for remote indication of:

- Manual load/unload or automatic operation (K07)
- Warning condition (K08)
- Shut-down condition (K05)

Example: K05 is a NO (NO = normally open) contact. It will be closed if all conditions are normal and will open in case of power failure or shutdown.

Maximum contact load: 10 A / 250 V AC.

Stop the compressor and switch off the voltage before connecting external equipment. Consult your supplier.

### Compressor control mode

On compressors equipped with an Elektronikon™ controller, consult section [Selection between local, remote and LAN control](#) if it is desired to switch to another control mode.

On compressors equipped with an Elektronikon™ Graphic controller, consult section [Control mode selection](#) if it is desired to switch to another control mode.

#### The following control modes can be selected:

- **Local control:** The compressor will react to commands entered by means of the buttons on the control panel. Compressor start/stop commands via Clock function are active, if programmed.
- **Remote control:** The compressor will react to commands from external switches. Emergency stop remains active. Compressor start/stop commands via Clock function are still possible.

Options:

- Remote starting and stopping (switch S1')
- Remote loading/unloading (switch S4')
- Remote pressure sensing (switch S' combined with pressure switch S4')



Have the modifications checked by your supplier.  
 Stop the compressor and switch off the voltage before connecting external equipment.  
 Only potential-free contacts are allowed.









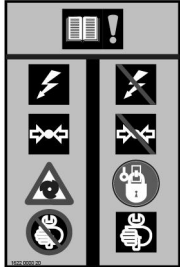

- **LAN control:** The compressor is controlled via a local network. Consult your supplier.

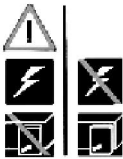

See service diagram 9828 5102 00 to locate the connectors.

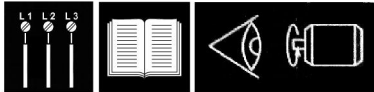
## 6.4 Pictographs

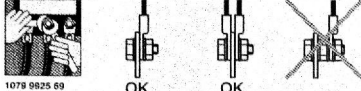
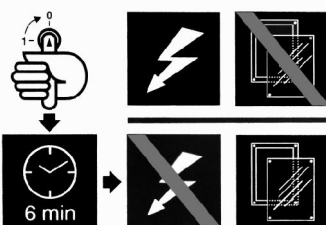
### Description

#### Pictographs

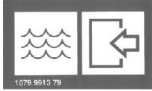
<p>1</p>	 <p>84224D</p>	<p>2</p>	 <p>84231D</p>																														
<p>3</p>	 <p>84230D</p>	<p>4</p>	 <p>84234D</p>																														
<p>5</p>	 <p>84221D</p>	<p>6</p>	 <p>1078 9901 18</p> <p>84219D</p>																														
<p>7</p>	 <p>84226D</p>	<p>8</p>	 <p>84228D</p>																														
<p>9</p>	 <p>1078 8804 99</p> <p>180 s</p> <p>0 bar pst</p> <p>84227D</p>	<p>10</p>	<table border="1" data-bbox="986 1438 1348 1568"> <thead> <tr> <th>Nm</th> <th>M2,5</th> <th>M3</th> <th>M3,5</th> <th>M4</th> <th>M5</th> <th>M6</th> <th>M8</th> <th>M10</th> <th>M12</th> </tr> </thead> <tbody> <tr> <td>-</td> <td>1.2</td> <td>1.2</td> <td>1.2</td> <td>2.7</td> <td>7</td> <td>12</td> <td>20</td> <td>30</td> <td></td> </tr> <tr> <td>0.5</td> <td>0.5</td> <td>0.8</td> <td>1.2</td> <td>-</td> <td>3</td> <td>6</td> <td>10</td> <td>15.5</td> <td></td> </tr> </tbody> </table>  <p>1078 9825 09</p> <p>OK OK</p> <p>84229D</p>	Nm	M2,5	M3	M3,5	M4	M5	M6	M8	M10	M12	-	1.2	1.2	1.2	2.7	7	12	20	30		0.5	0.5	0.8	1.2	-	3	6	10	15.5	
Nm	M2,5	M3	M3,5	M4	M5	M6	M8	M10	M12																								
-	1.2	1.2	1.2	2.7	7	12	20	30																									
0.5	0.5	0.8	1.2	-	3	6	10	15.5																									
<p>11</p>	 <p>1078 9901 61</p> <p>6 min</p> <p>84225D</p>	<p>12</p>	 <p>1078 3012 28</p> <p>84232D</p>																														

13	 84222D	14	 84223D
15	 84145D		

Reference	Designation
1	Warning: Always read the manual, switch off the voltage, depressurise compressor and lock out/ tag out before repairing.
2	Keep the doors closed during operation
3	Switch off the voltage before removing protecting cover inside electric cubicle
4	Warning, voltage
5	Automatic condensate drain
6	Stop the compressor before cleaning the coolers
7	Lightly oil the gasket of the oil filter, screw it on and tighten by hand (approx. half a turn)
8	Before connecting the compressor electrically, consult the Instruction book for the motor rotation direction
9	Compressor remains pressurized for 180 seconds after switching off the voltage
10	Torques for steel (Fe) or brass (CuZn) bolts
11	Switch off the voltage and wait at least 6 minutes before removing the screen
12	Oil outlet (option DD/PD filters)
13	Cooling water inlet
14	Cooling water outlet
15	Automatic Restart After Voltage Failure (ARAVF)

## 7 Operating instructions

### 7.1 Initial start-up

	The operator must apply all applicable <a href="#">Safety precautions</a> .
	For the location of the air outlet valve and the drain connections, see sections <a href="#">Introduction</a> and <a href="#">Condensate system</a> .

#### Preparations

1. Consult the sections [Electrical cable size](#), [Installation proposal](#) and [Dimension drawings](#).
2. **The following transport fixtures, painted red, must be removed:**
  - Bolt and bushes or support under the motor (1)
  - Bolts and bushes under the gear casing (2)
  - Bolts or bolts and bushes under the oil separator vessel (3)

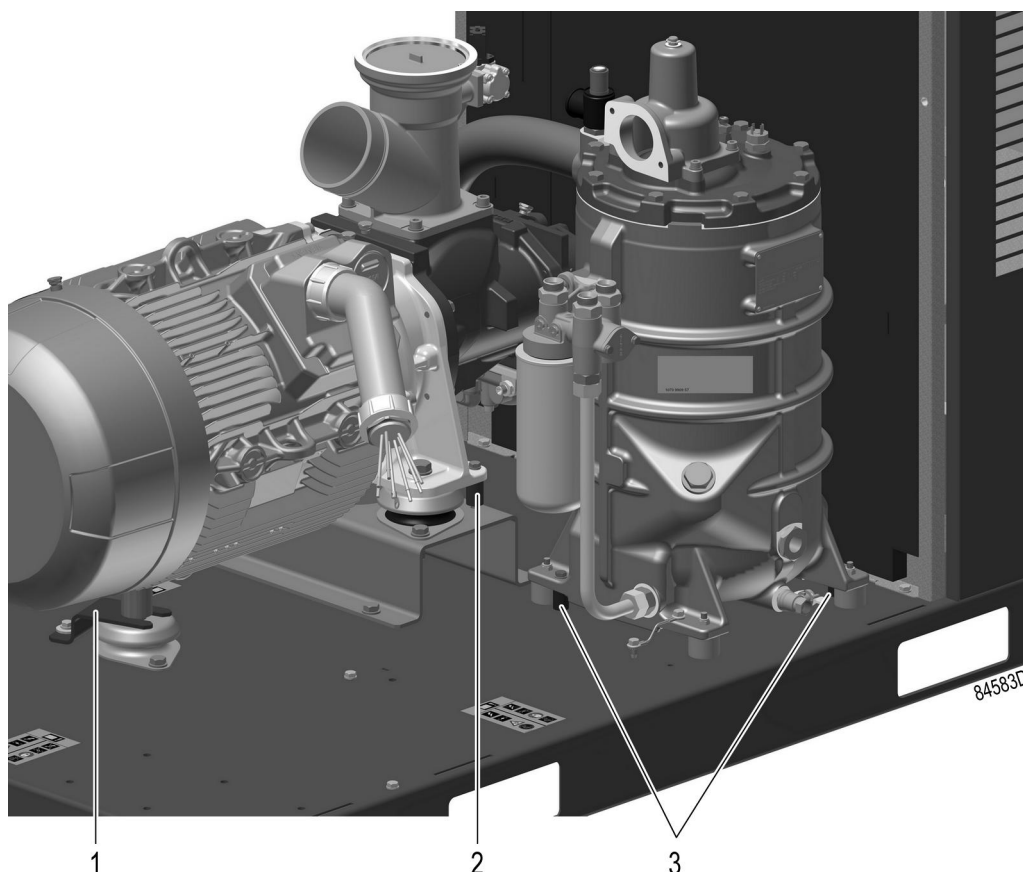

3. Check that the electrical connections correspond to the applicable codes and that all wires are clamped tight to their terminals.  
The installation must be earthed and protected against short circuits by fuses of the inert type in all phases. An isolating switch must be installed near the compressor.
4. Check transformer (T1) for correct connection.  
Check the settings of drive motor overload relay (F21).  
Check that the motor overload relay is set for manual resetting.

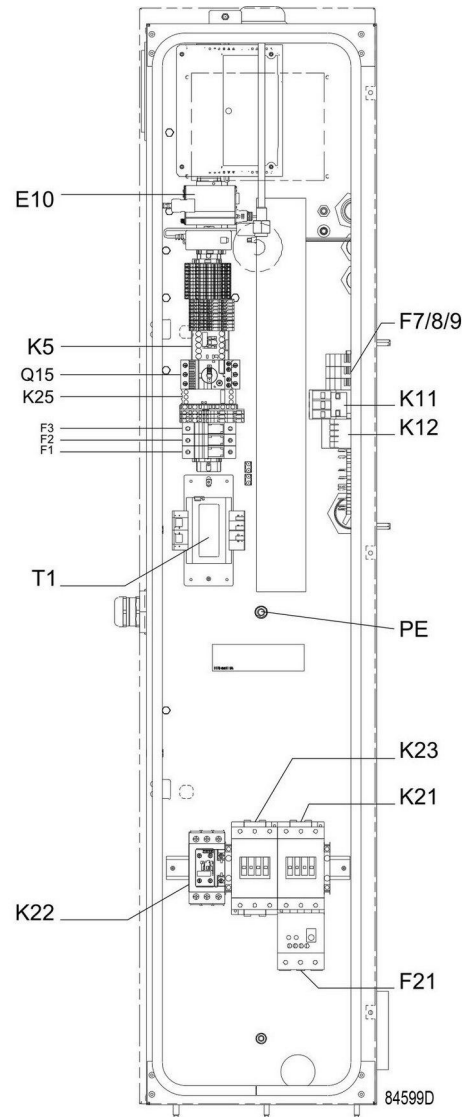

*Electric cubicle*

5. Check the setting of circuit breaker (Q15). Also check that the switch on the circuit breaker is in position I.
6. Fit air outlet valve (AV). See section [Introduction](#) for the location of the valve.  
Close the valve.  
Connect the air net to the valve.  
On compressors equipped with a dryer bypass, fit the air outlet valve to the dryer bypass pipe.
7. Connect the condensate drain outlet(s) to a drain collector.  
See section [Condensate system](#).  
The drain pipes to the drain collector must not dip into the water. If there is a risk for freezing, the pipes must be insulated.  
For draining of pure condensate water, install an oil/water separator which is available from Atlas Copco as an option.
8. For compressors with a DD or a DD and PD filter: connect the automatic drain of the filters to a suitable drain collector.
9. **Provide labels, warning the operator that:**

- The compressor may automatically restart after voltage failure (if activated, consult Atlas Copco).
- The compressor is automatically controlled and may be restarted automatically.

### Initial start procedure



If the compressor has not run for the past 6 months, it is strongly recommended to improve the lubrication of the compressor element before starting.

To do so:

1. Disconnect the inlet hose.
2. Remove the unloader (UA).
3. Pour approximately 0.75 l (0.20 US gal, 0.17 Imp gal) of compressor oil into the compressor element inlet. For oil specifications, see section [Oil specifications](#).
4. Reinstall the unloader and reconnect the inlet hose.

Make sure that all connections are tight.

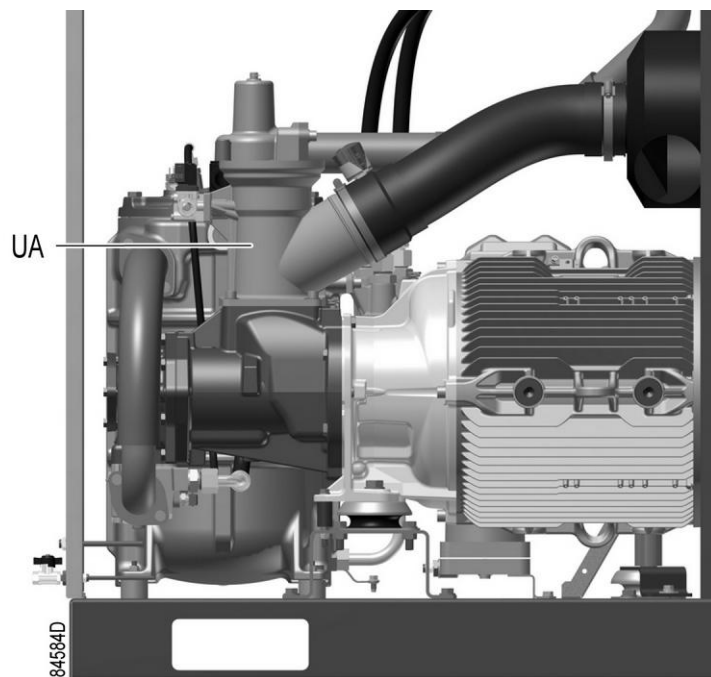

*Location of unloader*

1. Check the oil level before starting.  
The oil level should be between the oil filler neck (FC) and the bottom of the sight glass (GI).

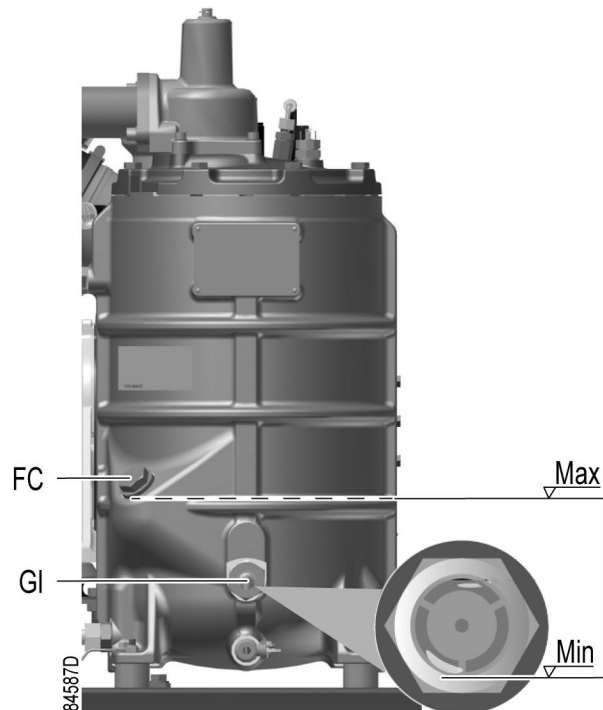

2. Switch on the voltage. Start the compressor and stop it immediately. Check the rotation direction of drive motor (M1) while the motor is coasting to a stop. The correct rotation direction of the drive motor is indicated by an arrow shown on the motor fan cowl. If the rotation direction of the drive motor is incorrect, open the isolating switch and reverse two incoming electric lines.  
**Incorrect rotation direction of the drive motor may cause damage to the compressor.**
3. Check also the rotation direction of the fan motor. Rotation arrows, visible through the grating in the roof, are provided on the plate below the fan to indicate the correct rotation direction of the fan motor.  
If the rotation direction of the fan motor is incorrect, open the isolating switch and reverse two incoming electric connections at the terminals of circuit breaker (Q15).
4. Check the programmed settings. For compressors equipped with an Elektronikon™ controller, consult section [Programmable settings](#).
5. Check the programmed settings. For compressors equipped with an Elektronikon™ Graphic controller, consult section [Programmable settings](#).
6. Start and run the compressor for a few minutes. Check that the compressor operates normally.
7. Check that the outlet temperature doesn't rise too much after start-up. The unit will shutdown when the outlet temperature is 65°C (149°F) above the inlet temperature.

## 7.2 Before starting

### Procedure

1. If the compressor has not run for the past 6 months, it is strongly recommended to improve the lubrication of the compressor element before starting. See section [Initial start](#).
2. Check oil level. Top up if necessary.

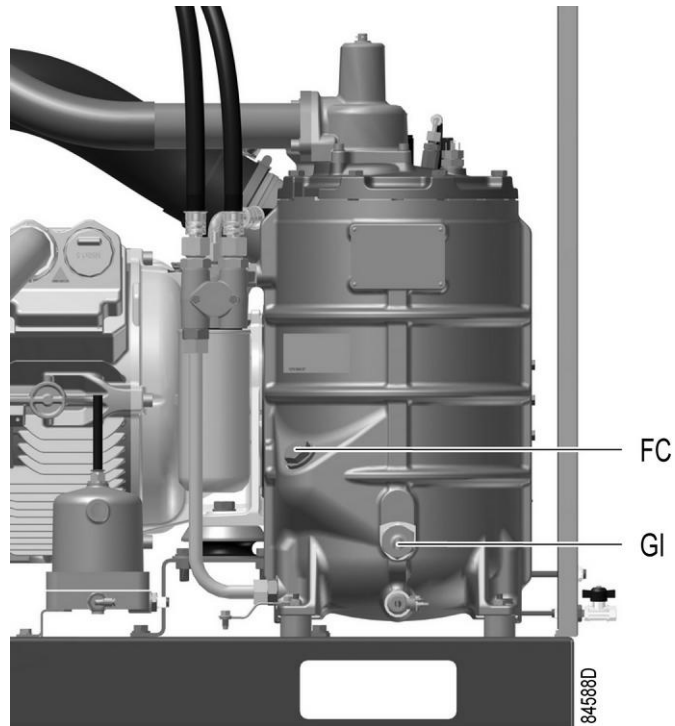

*Position of oil level sight glass*

3. If necessary, empty the dust trap of the filter, see section [Air filter](#).  
 If the red part of the air filter service indicator shows full out, replace the air filter element.  
 Reset the service indicator (VI) by pushing the knob in the extremity of the indicator.

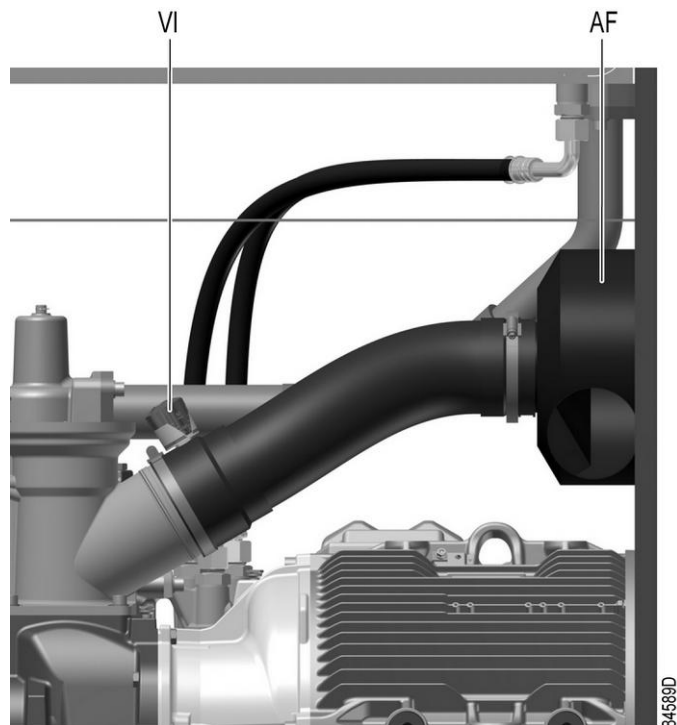

*Position of air filter and service indicator*

### 7.3 Starting

 For the position of the air outlet valve and the drain connections, see sections [Introduction](#) and [Condensate system](#).



Control panel Elektronikon™

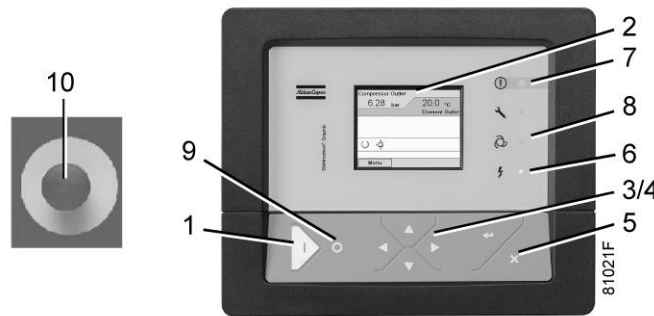



Control panel Elektronikon™ Graphic

#### Procedure

1. Open the air outlet valve.
2. Switch on the voltage. Check that voltage on LED (6) lights up.
3. Press start button (1) on the control panel. The compressor starts running and the automatic operation LED (8) lights up. Ten seconds after starting, the drive motor switches over from star to delta and the compressor starts running loaded.

## 7.4 During operation

### Warnings

	<p>The operator must apply all relevant <a href="#">Safety precautions</a>. Also consult section <a href="#">Problem solving</a>.</p>
	<p>Keep the doors closed during operation. They may be opened for short periods only to carry out checks.</p>
	<p>When the motors are stopped and LED (8) (automatic operation) is alight, the motors may start automatically.</p>

### Checking the oil level



Control panel Elektronikon™

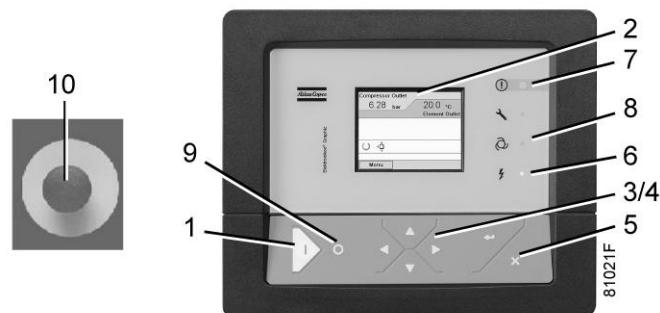

Control panel Elektronikon™ Graphic

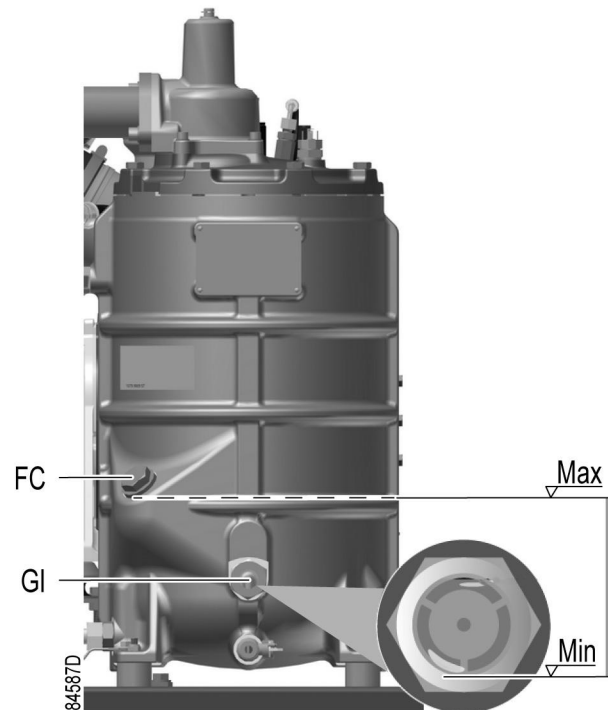

Regularly check the oil level. To do so:

1. Press stop button (9).
2. A few minutes after stopping, the oil level should be between the oil filler neck (FC) and the bottom of the sight glass (GI).
3. If the oil level is too low, push the emergency stop button (10) to avoid the compressor to start unexpectedly.
4. Next, close the air outlet valve and open the manual drain valve (Dm) until the air system between oil separator/air receiver vessel and outlet valve is fully depressurized. See section [Condensate system](#) for location of the outlet valve and water drain.
5. Unscrew oil filler plug (FC) one turn to permit any pressure left in the system to escape. Wait a few minutes.
6. Remove the plug and add oil until the level reaches the filler opening.
7. Fit and tighten the plug (FC).

On compressors equipped with an Elektronikon™ controller, unlock the emergency stop button (10) and press the 'Rset' key (5) before restarting.

On compressors equipped with an Elektronikon™ Graphic controller, unlock the emergency stop button (10), select the STOP icon on the display and press reset (5) before restarting.

**Air filter**

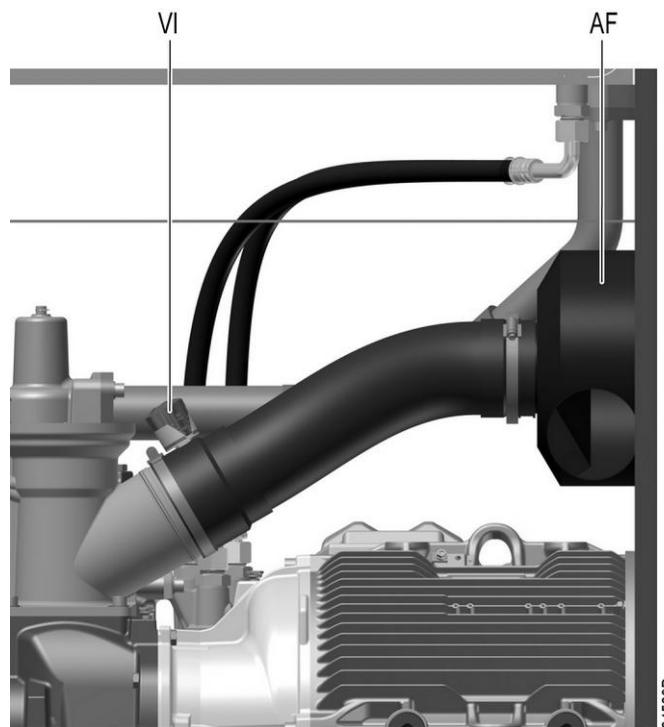

*Position of the service indicator*

Regularly check the service indicator. If the colored part of service indicator (VI) shows full out, replace the air filter element. Reset the service indicator by pushing the knob in the extremity of the indicator body.

**Drains**

Regularly check that condensate is discharged during operation. See section [Condensate system](#). The amount of condensate depends on environmental and working conditions.

**7.5 Checking the display**

Compressors with Elektronikon™ controller:



*Control panel Elektronikon™*

Check the display (2) regularly for readings and messages. The display normally shows the compressor outlet pressure, while the status of the compressor is indicated by pictographs. Remedy the trouble if alarm LED (7) is lit or flashes, see section [Shutdown warning](#), [Shutdown](#) and [Problem solving](#). The display (2) will show a service message if a service plan interval has been exceeded or if a service level for a monitored component has been exceeded. Carry out the service actions of the indicated plans or replace the component and reset the relevant timer, see section [Service warning](#).

**Compressors with Elektronikon™ Graphic controller:**

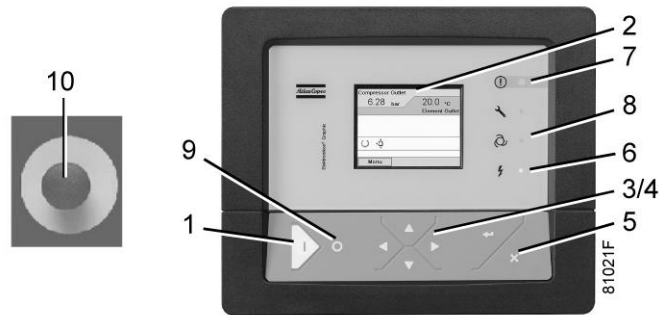

Control panel Elektronikon™ Graphic

Check the display (2) regularly for readings and messages. The display normally shows the compressor outlet pressure, while the status of the compressor is indicated by means of a number of icons. Remedy the trouble if alarm LED (7) is lit or flashes, see section [Icons used](#). The display (2) will show a service message if a service plan interval has been exceeded or if a service level for a monitored component has been exceeded. Carry out the service actions of the indicated plans or replace the component and reset the relevant timer, see section [Service menu](#).

**7.6 Stopping**



Control panel Elektronikon™

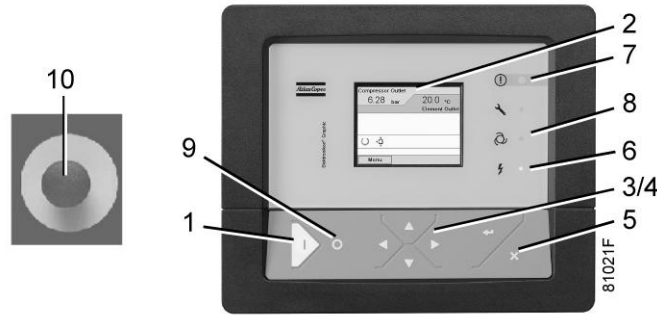

Control panel Elektronikon™ Graphic

**Procedure**

Step	Action
1	Press stop button (9). Automatic operation LED (8) goes out and the compressor stops after 30 seconds of unloaded operation.
2	<p><b>To stop the compressor in the event of an emergency</b>, press emergency stop button (10). Alarm LED flashes (7).</p> <p>On compressors equipped with an Elektronikon™ controller, remedy the problem cause, unlock the button by pulling it out and press the Escape button (5) to reset.</p> <ul style="list-style-type: none"> <li>• On compressors equipped with an Elektronikon™ Graphic controller, remedy the problem cause and unlock the button by pulling it out.</li> <li>• Navigate to the Stop icon on the display by means of the navigation keys (3/4) and press the Select key.</li> </ul> <p>Press Reset.</p> <p><b>Do not use emergency stop button (10) for normal stopping!</b></p>
3	Close the air outlet valve.
4	Press the test button on top of the electronic water drain(s) (if supplied) to the depressurize the piping between air receiver and outlet valve, next open the manual drain valve (Dm). See section <a href="#">Condensate system</a> . Switch off the voltage.

## 7.7 Taking out of operation

**Warning**

	The operator must apply all relevant <a href="#">Safety precautions</a> .
--	---

**Procedure**



Step	Action
-	Stop the compressor and close the air outlet valve.

Step	Action
-	Press the test button on top of the electronic water drain(s) until the air system between air receiver and outlet valve is fully depressurized. Consult section <a href="#">Condensate system</a> to locate the drain valve.
-	Switch off the voltage and disconnect the compressor from the mains.
-	Open the condensate drain valve(s) (Dm).
-	Unscrew the oil filler plug only one turn to permit any pressure in the system to escape. Consult section <a href="#">Oil and oil filter change</a> to locate the filler plug.
-	Shut off and depressurise the part of the air net which is connected to the outlet valve. Disconnect the compressor air outlet pipe from the air net.
-	Drain the oil.
-	Drain the condensate circuit and disconnect the condensate piping from the condensate net.

## 8 Maintenance

### 8.1 Preventive maintenance schedule

#### Warning

	<p>Always apply all relevant <a href="#">Safety precautions</a>.</p> <p><b>Before carrying out any maintenance, repair work or adjustments, proceed as follows:</b></p> <ul style="list-style-type: none"> <li>• Stop the compressor.</li> <li>• Close the air outlet valve and open the manual drain valve until the air system between air receiver and outlet valve is fully depressurized.</li> <li>• Press the emergency stop button.</li> <li>• Switch off the voltage. Open and lock the isolating switch.</li> <li>• Depressurize the compressor by opening the oil filler plug one turn.</li> </ul>
	<p>Only pressing the emergency stop button is not sufficient to make the compressor voltage free.</p> <p>If the machine is equipped with an automatic restart after voltage failure function and if this function is active, be aware that the machine will restart automatically when the power is restored if it was running when the power was interrupted.</p>

#### Warranty - Product Liability

Use only authorized parts. Any damage or malfunction caused by the use of unauthorized parts is not covered by Warranty or Product Liability.

#### Service kits

For overhauling or carrying out preventive maintenance, service kits are available. Consult the Spare Parts list for part numbers.

#### Service contracts

Atlas Copco offers several types of service contracts, relieving you of all preventive maintenance work. Consult your Atlas Copco Customer Centre.

#### General

When servicing, replace all removed O-rings and washers.

#### Intervals

The local customer centre may overrule the maintenance schedule, especially the service intervals, depending on the environmental and working conditions of the compressor.

The longer interval checks must also include the shorter interval checks.

#### Regular maintenance

Following actions have to be done on a regular basis:

Maintenance checklist

Period	Operation
Daily	Check oil level. Check readings on the controller display. Check the air filter service indicator. Check that condensate is discharged during operation of the compressor. Drain condensate. Check the pressure dew point temperature (on compressors with integrated dryer).
3-monthly (1)	Check coolers. Clean if necessary. Check cooling fins of electric motor(s). Clean if necessary. Remove the air filter element and inspect. If necessary, clean using an air jet. Replace damaged or heavily contaminated elements. Check the filter element of the electric cabinet. Replace if necessary. On compressors with integrated dryer: <ul style="list-style-type: none"> <li>• Stop the compressor, close the air outlet valve and switch off the voltage.</li> <li>• Remove any dirt from the condenser inlet with a vacuum cleaner.</li> <li>• Next, clean with an air jet in the reverse direction of the normal flow. Use low pressure air. Keep the compressed air nozzle more than 30 cm away from the condenser to avoid damaging the condenser fins.</li> <li>• Remove dust from inside the dryer, e.g. with a vacuum cleaner.</li> </ul> Do not use water or solvents to clean the condenser.
Yearly	Check the condition of all hoses. Replace if necessary.

(1): More frequently when operating in a dusty atmosphere

**Programmed service interventions**

Apart from the above mentioned actions, a number of service interventions (see the table below) are programmed in the controller. Each plan has a programmed time interval at which all service actions belonging to that plan are to be carried out. When reaching the interval, a message will appear on the screen indicating which service plans are to be carried out.

See section [Service warning](#) for compressors with an Elektronikon™ controller.

See section [Service menu](#) for compressors with an Elektronikon™ Graphic controller.

After servicing, the intervals must be reset.

See section [Calling up/resetting the service timer](#) for compressors with an Elektronikon™ controller.

See section [Service menu](#) for compressors with an Elektronikon™ Graphic controller.

Preventive Maintenance schedule programmed in the Elektronikon™

	A-service Every 4000 running hours (1)	B-service Every 8000 running hours (2)	D-Service Every 24000 running hours
Change the air filter	x	x	x
Change the electric cabinet filter mats	x	x	x
Change the oil	x (3)	x	x
Change the oil filter	x (3)	x	x
Change the oil separator element		x	x

Overhaul non return valve of the scavenge line		x	x
Overhaul the unloader		x	x
Overhaul the minimum pressure valve		x	x
Change the thermostatic valve		x	x
Overhaul the condensate drain(s)		x	x
Overhaul the main drive motor			x
Overhaul the compressor element			x (4)

(1): or yearly (indicated by real time counter), whichever comes first.

(2): or every 2 years (indicated by real time counter), whichever comes first.

(3): If Roto-Xtend Duty Fluid and the corresponding oil filter is used, the oil and oil filter change are part of the B service. See also section [Oil specifications](#).

(4): For compressor elements used on operating pressures below or equal to 10 bar (145 psi), the overhaul can be postponed to 32000 running hours.



- Consult your supplier before modifying a timer setting.
- For the change interval of oil and oil filter in extreme conditions consult your customer centre.
- Any leakage should be attended to immediately. Damaged hoses or flexible joints must be replaced.

## 8.2 Oil specifications

It is strongly recommended to use genuine lubricants from your manufacturer. They are the result of years of field experience and research. See section Preventive maintenance schedule for the advised replacement intervals and consult the Spare Parts list for part number information.



Avoid mixing lubricants of different brands or types as they may not be compatible and the oil mix may have inferior properties. A label, indicating the type of oil filled ex factory, is stuck on the air receiver/oil tank or on the compressor frame.

### Roto-Inject Fluid Ndurance

Atlas Copco's Roto-Inject Fluid Ndurance is a specially developed lubricant for use in single stage oil injected screw compressors. Its specific composition keeps the compressor in excellent condition.

See the table below for oil exchange intervals:

Ambient temperature	Element outlet temperature	Exchange interval	Maximum time interval
up to 30°C (95°F)	up to 95°C (203°F)	4000	1 year
from 30°C (86°F) up to 35°C (95°F)	from 95°C (203°F) up to 100°C (212°F)	3000	1 year
from 35°C (95°F) up to 40°C (104°F)	from 100°C (212°F) up to 105°C (221°F)	2000	1 year
above 40°C (104°F)	above 105°C (221°F)	use ROTO-Xtend Duty Fluid	use ROTO-Xtend Duty Fluid

### Roto-Xtend Duty Fluid

Atlas Copco's Roto-Xtend Duty Fluid is a high quality synthetic lubricant for oil-injected screw compressors which keeps the compressor in excellent condition.

See the table below for oil exchange intervals:

Ambient temperature	Element outlet temperature	Exchange interval	Maximum time interval
up to 35°C (95°F)	up to 100°C (212°F)	8000	2 years
from 35°C (95°F) up to 40°C (104°F)	from 100°C (212°F) up to 105°C (221°F)	6000	2 years
above 40°C (104°F)	above 105°C (221°F)	5000	2 years

### Roto-Foodgrade Fluid

Atlas Copco's Roto-Foodgrade Fluid is a unique high quality synthetic lubricant, specially created for oil-injected screw compressors that provide air for the food industry.

See the table below for oil exchange intervals:

Ambient temperature	Element outlet temperature	Exchange interval	Maximum time interval
up to 35°C (95°F)	up to 100°C (212°F)	4000	1 year
from 35°C (95°F) up to 40°C (104°F)	from 100°C (212°F) up to 105°C (221°F)	3000	1 year
from 40°C (104°F) up to 45°C (113°F)	from 105°C (221°F) up to 110°C (230°F)	2000	1 year
above 45°C (113°F)	above 110°C (230°F)	use not recommended	use not recommended

## 8.3 Drive motor

### General

Keep the outside of the electric motor clean for efficient cooling. If necessary, remove dust with a brush and/or compressed air jet.

## 8.4 Air filter

### Location of air filter

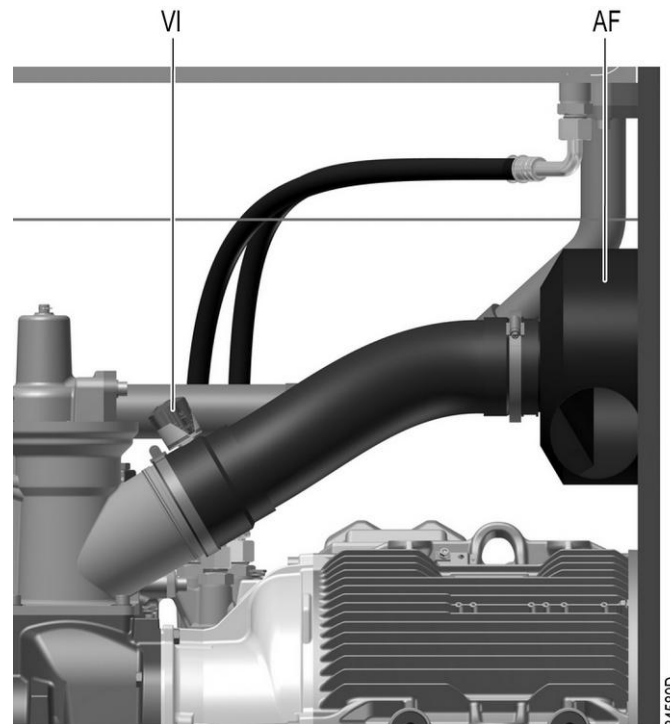

### Recommendations

1. Never remove the element while the compressor is running.
2. For minimum downtime, replace the dirty element by a new one.
3. Discard the element when damaged.

### Procedure

1. Stop the compressor. Switch off the voltage.
2. Release the snap clips of air filter (AF) and remove the cover and the air filter element. Discard the filter element.
3. Fit the new element and the cover.
4. Reset service indicator (VI) by pushing the knob in the extremity of the body.
5. Reset the air filter service warning.  
For compressors equipped with a standard controller, see section [Service warning](#).  
For compressors equipped with a graphic controller, see section [Service menu](#).

## 8.5 Oil and oil filter change

### Warning

	<p>The operator must apply all relevant <a href="#">Safety precautions</a>.                  Always drain the compressor oil at all drain points. Used oil left in the compressor can contaminate the oil system and can shorten the lifetime of the new oil.                  Never mix lubricants of different brands or types as they may not be compatible and the oil mix will have inferior properties. A label, indicating the type of oil filled ex-factory, is stuck on the air receiver/oil tank.                  If the compressor is equipped with an Energy Recovery system, also consult <a href="#">Maintenance for Energy Recovery Systems</a>.</p>
--	--

### Procedure

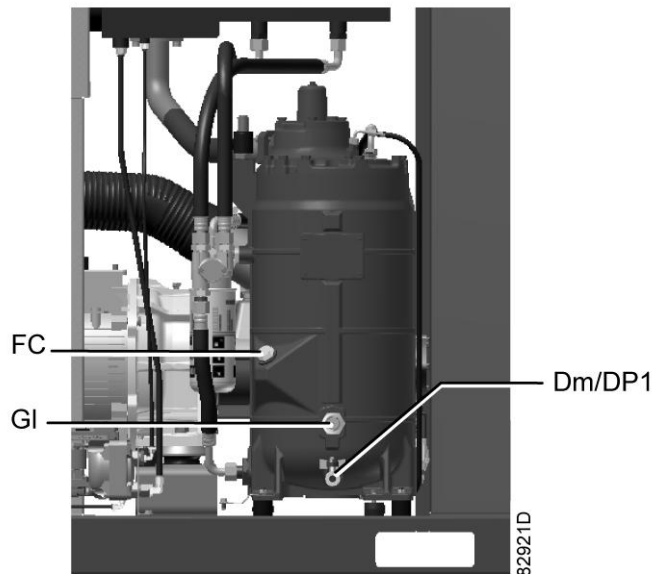

*Oil drain and filler plug on the oil separator vessel*

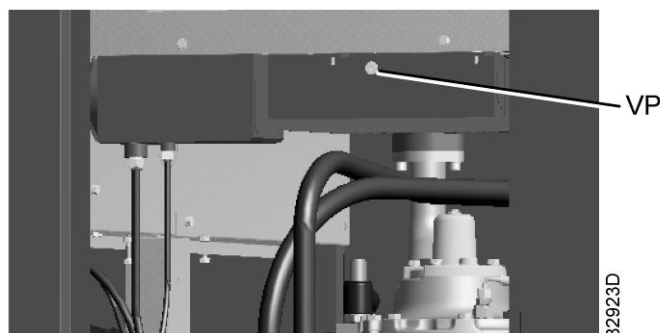

*Vent plug, oil cooler*

Step	Description
1	Run the compressor until warm. Stop the compressor after 3 minutes of unloaded operation. Close the air outlet valve and switch off the voltage. Wait a few minutes and depressurise by unscrewing oil filler plug (FC) just one turn to permit any pressure in the system to escape.
2	Air cooled units: loosen the vent plug (VP) of the oil cooler and wait for 5 minutes.
3	Remove drain plug (DP1) and open drain valve (Dm).
4	Collect the oil in a collector and deliver it to the local collection service. Refit and tighten the drain and vent plugs after draining. Close the drain valve (Dm).
5	Remove the oil filter (OF). <b>Be aware that this filter has a left thread connection.</b> Clean the seat on the manifold. Oil the gasket of the new filter and screw it into place. Tighten firmly by hand.
6	Remove filler plug (FC). Fill the air receiver (AR) with oil until the level reaches the filler neck. Take care that no dirt drops into the system. Refit and tighten filler plug (FC).
7	Run the compressor loaded for a few minutes. Stop the compressor and wait a few minutes to allow the oil to settle.
8	Depressurise the system by unscrewing filler plug (FC) just one turn to permit any pressure in the system to escape. Remove the plug. Fill the air receiver with oil until the level reaches the filler neck. Tighten the filler plug.
9	Reset the service warning after carrying out all service actions in the relevant Service Plan: For compressors with a standard controller, see section <a href="#">Calling up/resetting the service timer</a> . For compressors with a graphic controller, see section <a href="#">Service menu</a> .

## 8.6 Coolers

### General

Keep the coolers clean to maintain their efficiency.

### Instructions for air-cooled compressors

- Stop the compressor, close the air outlet valve and switch off the voltage.
- Cover all parts under the coolers.
- Remove the service plates. (1)

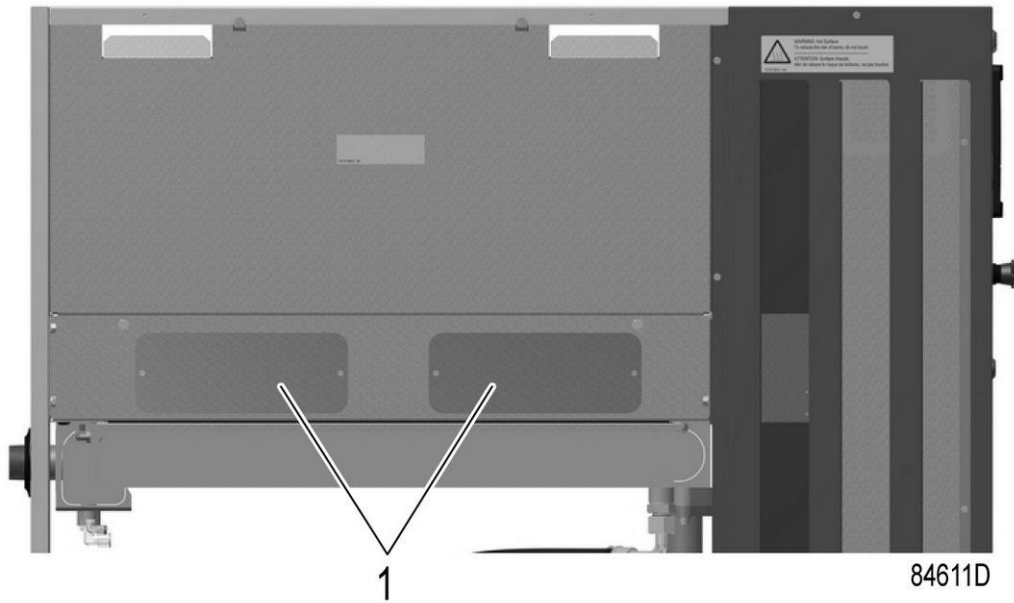

- Remove any dirt from the coolers with a fibre brush. Brush in the direction of the cooling fins. Also remove any dirt from the fan with a fibre brush.
- Next, clean with an air jet in the reverse direction to normal flow. Use low pressure air. If necessary, the pressure may be increased up to 6 bar(e) (87 psig).
- If it is necessary to wash the coolers with a cleaning agent, consult your supplier.
- Remove the cover used during cleaning.
- Mount the service plates. (1)

## 8.7 Safety valves

### Location of safety valve

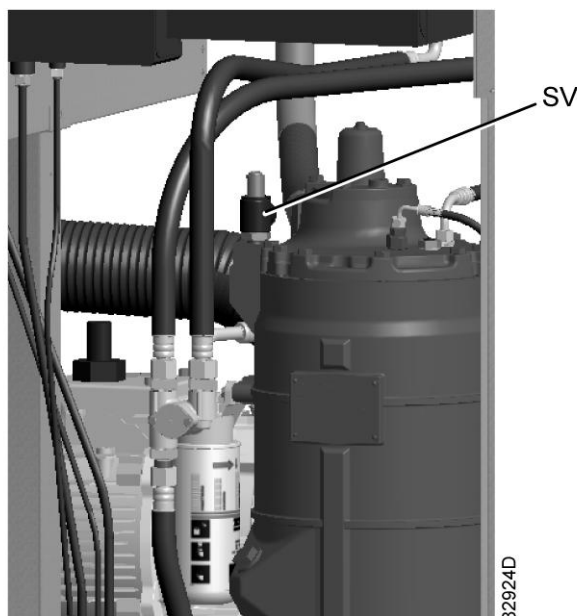

*Position of safety valve*

### Operating

Operate the safety valve from time to time by unscrewing the cap one or two turns. Retighten it afterwards.

### Testing

Before removing the valve, depressurize the compressor. See also section Problem solving.

The safety valve (SV) can be tested on a separate air line. If the valve does not open at the set pressure stamped on the valve, it needs to be replaced.

### Warning

No adjustments are allowed. Never run the compressor without safety valve.

## 8.8 Dryer maintenance instructions

### Safety precautions

Refrigeration dryers of ID type contain refrigerant HFC.

**When handling refrigerant, all applicable [safety precautions](#) must be observed. Please be specifically aware of the following points:**

- Contact of refrigerant with the skin will cause freezing. Special gloves must be worn. If contacted with the skin, the skin should be rinsed with water. On no account may clothing be removed.
- Fluid refrigerant will also cause freezing of the eyes; always wear safety glasses.
- Refrigerant is harmful. Do not inhale refrigerant vapours. Check that the working area is adequately ventilated.

Be aware that certain components such as the refrigerant compressor and the discharge pipe can become quite hot (up to 110 °C - 230 °F). Therefore, wait until the dryer has cooled down before removing the panels.

Before starting any maintenance or repair work, switch off the voltage and close the air inlet and outlet valves.

## Local legislation

### Local legislation may stipulate that:

- Work on the refrigerant circuit of the cooling dryer or on any equipment which influences its function must be undertaken by an authorised control body.
- The installation should be checked once a year by an authorised control body.

## General

For all references see section Introduction.

### The following remarks should be kept in mind:

- Keep the dryer clean.
- Brush or blow off the finned surface of condenser monthly.
- Stop the compressor, close the air outlet valve and switch off the voltage.
- Remove any dirt on the condenser inlet with a vacuum cleaner.
- Next, clean with an air jet in the reverse direction to normal flow. Use low pressure air. If necessary, the pressure may be increased up to 6 bar(e) (87 psig).
- Clean the condenser area with a vacuum cleaner.
- Inspect and clean the electronic condensate drain monthly.

## 8.9 Service kits

### Service kits

For overhauling and for preventive maintenance, a wide range of service kits is available. Service kits comprise all parts required for servicing the component and offer the benefits of genuine parts while keeping the maintenance budget low.

Also a full range of extensively tested lubricants, suitable for your specific needs is available to keep the compressor in excellent condition.

Consult the Spare Parts List for part numbers.

## 8.10 Storage after installation

### Procedure

Run the compressor regularly, e.g. twice a week, until warm. Load and unload the compressor a few times.



If the compressor is going to be stored without running from time to time, protective measures must be taken. Consult your supplier.



## 8.11 Disposal of used material

Used filters or any other used material (e.g. desiccant, lubricants, cleaning rags, machine parts, etc.) must be disposed of in an environmentally friendly and safe manner, and in line with the local recommendations and environmental legislation.

Electronic components are subject to the EU Directive 2012/19/EC for Waste Electrical and Electronic Equipment (WEEE). As such, these parts must not be disposed of at a municipal waste collection point. Refer to local regulations for directions on how to dispose of this product in an environmental friendly manner.

## 9 Problem solving

### Warning

	<p>Always apply all relevant <a href="#">Safety precautions</a>.</p>
	<p>Before carrying out any maintenance, repair work or adjustment, press the stop button, wait until the compressor has stopped and close the air outlet valve.                  Open the manual drain valve(s).                  Press the emergency stop button and switch off the voltage. Open and lock the isolating switch.                  Depressurise the oil separator vessel by opening the oil filler plug one turn.                  For location of components: see sections <a href="#">Introduction</a>, <a href="#">Condensate system</a> and <a href="#">Initial start</a>.</p>
	<p>The air outlet valve can be locked during maintenance or repair as follows:</p> <ul style="list-style-type: none"> <li>• Close the valve.</li> <li>• Remove the screw fixing the handle with the wrench delivered with the compressor.</li> <li>• Lift the handle and turn it until the slot of the handle fits over the blocking edge on the valve body.</li> <li>• Fit the screw.</li> </ul>
	<ul style="list-style-type: none"> <li>• Always switch off the voltage. Only pressing the emergency stop button is not sufficient to make the compressor voltage free.</li> <li>• If the machine is equipped with an automatic restart after voltage failure function and if this function is active, be aware that the machine will restart automatically when the power is restored if it was running when the power was interrupted.</li> </ul>

### Faults and remedies, compressor

On compressors equipped with a standard controller, if the alarm LED is lit or flashes, consult sections [Shutdown warning](#) , [Shutdown](#) and [Service warning](#).

On compressors equipped with a graphic controller, if the alarm LED is lit or flashes, consult sections [Event history menu](#) or [Service menu](#).

Condition	Fault	Remedy
Compressor does not start or stops during operation. Controller shows motor overload problem.	Motor overload relay (F21) open	Find cause and remedy. Replace if necessary.
	Circuit breaker (Q15) or fan motor overload (F15) open	Find cause and remedy. Replace if necessary.

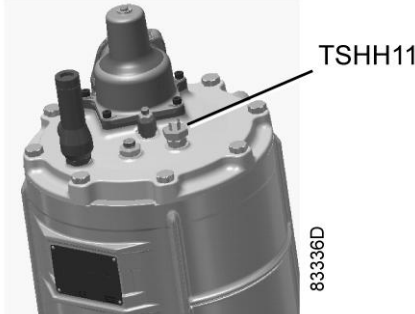
Condition	Fault	Remedy	
	<p>Too high temperature in oil separator vessel or temperature switch (TSHH1) defective</p> 	Find cause and remedy. Replace if necessary.	
	Phase sequence relay (K25) open	Find cause and remedy. Replace if necessary.	
	Wiring interrupted	Find cause and remedy. Replace if necessary.	
Compressor starts running, but does not load after a delay time	Solenoid valve out of order	Replace valve	
	Inlet valve stuck in closed position	Have valve checked	
	Leak in control air tubes	Replace leaking tubes	
	Minimum pressure valve leaking (when air net is depressurised)	Have valve checked	
Compressor does not unload, safety valve blows	Solenoid valve out of order	Replace valve	
	Inlet valve does not close	Have valve checked	
Condensate is not discharged from condensate separator during loading	Discharge tube clogged	Check and correct as necessary	
Compressor air output or pressure below normal	Air consumption exceeds air delivery of compressor	Check the connected equipment.	
	Choked air filter element	Replace filter element	
	Solenoid valve malfunctioning	Replace valve	
	Leak in control air tubes	Replace leaking tubes	
	Oil separator element clogged	Have element replaced	
	Air leakage	Have leaks repaired.	
	Safety valve leaking	Replace valve	
	Inlet valve does not fully open	Have valve checked	
	Compressor element out of order	Consult your supplier	
	Excessive oil consumption; oil carry-over through discharge line	Incorrect oil causing foam	Change to correct oil
		Oil level too high	Check for overfilling. Release pressure and drain oil to correct level.
		Oil separator defective	Replace oil separator element
	Safety valve blows after loading	Inlet valve malfunctioning	Have valve checked

Condition	Fault	Remedy
	Minimum pressure valve malfunctioning	Have valve checked
	Safety valve out of order	Have valve replaced
	Oil separator element clogged	Have oil separator element replaced
	Compressor element out of order	Consult your supplier
Compressor element outlet temperature or delivery air temperature above normal	Oil level too low	Check and correct
	Insufficient cooling air or cooling air temperature too high	Check for cooling air restriction or improve ventilation of the compressor room. Avoid recirculation of cooling air. If installed, check capacity of compressor room fan
	Oil cooler clogged	Clean cooler
	Bypass valve malfunctioning	Have valve tested
	Air cooler clogged	Clean cooler
	Compressor element out of order	Consult your supplier
Cooling air fan does not deliver enough air.	Unit shuts down due to overtemperature, fan overload, too high oil consumption or less FAD.	Fan rotates in the wrong direction due to wrong electrical connection.

### Faults and remedies, dryer

For all references hereafter, consult section [Air dryer](#).

Condition	Fault	Remedy
Pressure dew point too high	Air inlet temperature too high	Check and correct; if necessary, clean the aftercooler of the compressor
	Ambient temperature too high	Check and correct; if necessary, draw cooling air via a duct from a cooler place or relocate the compressor
	Shortage of refrigerant	Have circuit checked for leaks and recharged
	Refrigerant compressor does not run	See below
	Evaporator pressure too high	See below
	Condenser pressure too high	See below
Condenser pressure too high or too low	Fan control switch out of order	Replace
	Fan blades or fan motor out of order	Have checked fan/fan motor, if necessary replace.
	Ambient temperature too high	Check and correct; if necessary, draw cooling air via a duct from a cooler place or relocate the compressor
	Condenser externally clogged	Clean condenser

Condition	Fault	Remedy
Compressor stops or does not start	Electric power supply to compressor is interrupted	Check and correct as necessary
	Thermal protection of refrigerant compressor motor has tripped	Motor will restart when motor windings have cooled down
Condensate drain remains inoperative	Drain system clogged	Have system inspected Clean the filter of the drain by opening the manual drain valve. On units with an electronic drain, check functioning of the drain by pushing the test button.
Condensate trap continuously discharges air and water	Drain out of order	Have system checked. If necessary, replace the drain.
Evaporator pressure is too high or too low at unload	Hot gas bypass valve incorrectly set or out of order	Have hot gas bypass valve adjusted
	Condenser pressure too high or too low	See above
	Shortage of refrigerant	Have circuit checked for leaks and recharged if necessary

## 10 Technical data

### 10.1 Readings on display



81022F

*Elektronikon™ Controller*



81028F

*Elektronikon™ Graphic Controller*

#### Important



The readings mentioned below are valid under the reference conditions (see section [Reference conditions and limitations](#)).

Reference	Reading
Air outlet pressure	Modulates between programmed unloading and loading pressures.
Compressor element outlet temperature	Approx. 60 °C (108 °F) above cooling air inlet temperature.
Dewpoint temperature	See section <a href="#">Compressor data</a> .

## 10.2 Electric cable size and fuses

### Important



- The voltage on the compressor terminals must not deviate more than 10% of the nominal voltage.  
It is however highly recommended to keep the voltage drop over the supply cables at nominal current below 5% of the nominal voltage (IEC 60204-1).
  - If cables are grouped together with other power cables, it may be necessary to use cables of a larger size than those calculated for the standard operating conditions.
  - Use the original cable entry. See section [Dimension drawings](#).
- To preserve the protection degree of the electric cubicle and to protect its components from dust from the environment, it is mandatory to use a fitting cable gland when connecting the supply cable to the compressor.**
- Local regulations remain applicable if they are stricter than the values proposed below.
  - Currents are calculated with the full service factor but we suggest to add 10% due to over- and under-voltage.  
Fuses are maximum allowed values calculated for full service factor and 10% over- and under-voltage.
  - **Caution:**
    - Always double-check the fuse size versus the calculated cable size. If required, reduce fuse size or enlarge cable size.
    - Cable length should not exceed the maximum length according to IEC60204 table 10

### Currents and fuses

IEC approval

Compressor type			I (1)	Max. fuse (1)	I (2)	Max. fuse (2)
				gL/gG		gL/gG
	V	Hz	A	A	A	A
GA 30 <sup>+</sup>	230	50	119.9	160	129.6	160
GA 30 <sup>+</sup>	230	60	121.8	160	129.8	160
GA 30 <sup>+</sup>	380	60	73.2	100	78	100
GA 30 <sup>+</sup>	400	50	68.7	80	72.6	80
GA 30 <sup>+</sup>	460	60	61.2	80	65.3	80
GA 30 <sup>+</sup>	500	50	55	63	59.1	80

UL/cUL approval

Compressor type			I (1)	Max. fuse (1)	I (2)	Max. fuse (2)
				K5/ HRC form II		K5/ HRC form II
	V	Hz	A	A	A	A
GA 30 <sup>+</sup>	230	60	121.8	150	129.8	150
GA 30 <sup>+</sup>	460	60	61.2	70	65.3	80
GA 30 <sup>+</sup>	575	60	49.3	60	53.4	60

IEC approval

Compressor type			I (1)	Max. fuse (1)	I (2)	Max. fuse (2)
				gL/gG		gL/gG
	V	Hz	A	A	A	A
GA 37	230	50	137.0	160	146.7	200
GA 37	230	60	137.6	160	148	200
GA 37	380	60	86.4	100	91.2	125
GA 37	400	50	80.9	100	84.8	100
GA 37	460	60	71.4	80	77.8	100
GA 37	500	50	63.2	80	69.5	80

UL/cUL approval

Compressor type			I (1)	Max. fuse (1)	I (2)	Max. fuse (2)
				K5/ HRC form II		K5/ HRC form II
	V	Hz	A	A	A	A
GA 37	230	60	137.6	175	148	175
GA 37	460	60	71.4	80	77.8	90
GA 37	575	60	57.1	70	62.8	70

IEC approval

Compressor type			I (1)	Max. fuse (1)	I (2)	Max. fuse (2)
				gL/gG		gL/gG
	V	Hz	A	A	A	A
GA 45	230	50	169.2	200	178.9	200
GA 45	230	60	172.6	200	183.0	224
GA 45	380	60	104.7	125	109.5	125
GA 45	400	50	97.0	125	100.9	125
GA 45	460	60	87.2	100	93.5	125
GA 45	500	50	78.1	100	84.5	100

UL/cUL approval

Compressor type	V	Hz	I (1)	Max. fuse (1)	I (2)	Max. fuse (2)
				K5/ HRC form II		K5/ HRC form II
			A	A	A	A
GA 45	230	60	172.6	200	183.0	225
GA 45	460	60	87.2	100	93.5	110
GA 45	575	60	69.3	80	75.0	90

I: current in the supply lines at maximum load and nominal voltage

(1): compressors without integrated dryer

(2): compressors with integrated dryer

**Fuse calculations for IEC** are done according to 60364-4-43 Low-voltage electrical installations - Part 4-43: protection against overcurrent. Fuse sizes are calculated in order to protect the cable against short circuit.

**Fuse calculations for cUL and UL:** The indicated fuse size is the maximum fuse size in order to protect the motor against short circuit. For cUL fuse HRC form II, for UL fuse class RK5.

**Possible configurations**

There are 3 possible cabling layouts:

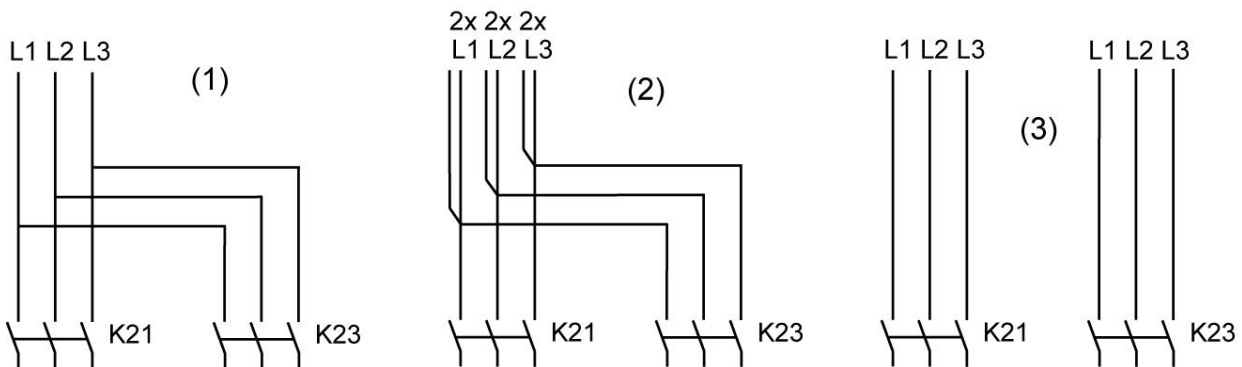

- (1): Single supply cables.
- (2): Parallel supply cables
- (3) is only valid for Y-D versions

**Cable sizing according IEC**

The tables below indicate the current carrying capacities of cables for commonly used installation methods, calculated according to standard 60364-5-52 - electrical installations of buildings part 5 - selection and erection equipment and section 52 - current carrying capacities in wiring systems.

The allowed currents are valid for PVC insulated cables with three loaded copper conductors. See tables for maximum conductor temperature 70 °C and for maximum conductor temperature 90°C.

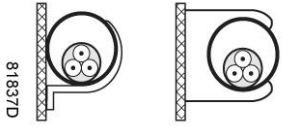

Installation method B2 according table B.52.1.  
Multi-core cable in conduit on a wooden wall

Maximum allowed current in function of the ambient temperature for installation method B2

Cable section	Ambient temperature				
	30 °C	40 °C	45 °C	50 °C	55 °C
4 mm <sup>2</sup>	< 27 A	< 23 A	< 21 A	< 19 A	< 16 A
6 mm <sup>2</sup>	< 34 A	< 30 A	< 27 A	< 24 A	< 21 A
10 mm <sup>2</sup>	< 46 A	< 40 A	< 36 A	< 33 A	< 28 A
16 mm <sup>2</sup>	< 62 A	< 54 A	< 49 A	< 44 A	< 38 A
25 mm <sup>2</sup>	< 80 A	< 70 A	< 63 A	< 57 A	< 49 A
35 mm <sup>2</sup>	< 99 A	< 86 A	< 78 A	< 70 A	< 60 A
50 mm <sup>2</sup>	< 118 A	< 103 A	< 93 A	< 84 A	< 72 A
70 mm <sup>2</sup>	< 149 A	< 130 A	< 118 A	< 106 A	< 91 A
95 mm <sup>2</sup>	< 179 A	< 156 A	< 141 A	< 127 A	< 109 A
120 mm <sup>2</sup>	< 206 A	< 179 A	< 163 A	< 146 A	< 126 A

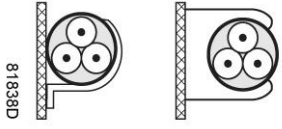

Installation method C according table B.52.1.  
Single-core or multi-core cable on a wooden wall

Maximum allowed current in function of the ambient temperature for installation method C

Cable section	Ambient temperature				
	30 °C	40 °C	45 °C	50 °C	55 °C
4 mm <sup>2</sup>	< 32 A	< 28 A	< 25 A	< 23 A	< 20 A
6 mm <sup>2</sup>	< 41 A	< 36 A	< 32 A	< 29 A	< 25 A
10 mm <sup>2</sup>	< 57 A	< 50 A	< 45 A	< 40 A	< 35 A
16 mm <sup>2</sup>	< 76 A	< 66 A	< 60 A	< 54 A	< 46 A
25 mm <sup>2</sup>	< 96 A	< 84 A	< 76 A	< 68 A	< 59 A
35 mm <sup>2</sup>	< 119 A	< 104 A	< 94 A	< 84 A	< 73 A
50 mm <sup>2</sup>	< 144 A	< 125 A	< 114 A	< 102 A	< 88 A
70 mm <sup>2</sup>	< 184 A	< 160 A	< 145 A	< 131 A	< 112 A
95 mm <sup>2</sup>	< 223 A	< 194 A	< 176 A	< 158 A	< 136 A
120 mm <sup>2</sup>	< 259 A	< 225 A	< 205 A	< 184 A	< 158 A

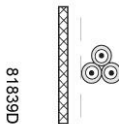
	<p>Installation method F according table B.52.1.                  Single core cables, touching in free air                  Clearance to wall not less than one cable diameter</p>
---	--

Maximum allowed current in function of the ambient temperature for installation method F, conductor temperature 70°C

Cable section	Ambient temperature				
	30 °C	40 °C	45 °C	50 °C	55 °C
25 mm <sup>2</sup>	< 110 A	< 96 A	< 87 A	< 78 A	< 67 A
35 mm <sup>2</sup>	< 137 A	< 119 A	< 108 A	< 97 A	< 84 A
50 mm <sup>2</sup>	< 167 A	< 145 A	< 132 A	< 119 A	< 102 A
70 mm <sup>2</sup>	< 216 A	< 188 A	< 171 A	< 153 A	< 132 A
95 mm <sup>2</sup>	< 264 A	< 230 A	< 209 A	< 187 A	< 161 A
120 mm <sup>2</sup>	< 308 A	< 268 A	< 243 A	< 219 A	< 188 A
150 mm <sup>2</sup>	< 356 A	< 310 A	< 281 A	< 253 A	< 217 A
185 mm <sup>2</sup>	< 409 A	< 356 A	< 323 A	< 290 A	< 249 A
240 mm <sup>2</sup>	< 485 A	< 422 A	< 383 A	< 344 A	< 296 A
300 mm <sup>2</sup>	< 561 A	< 488 A	< 443 A	< 398 A	< 342 A
400 mm <sup>2</sup>	< 659 A	< 573 A	< 518 A	< 467 A	< 402 A

Maximum allowed current in function of the ambient temperature for installation method F, conductor temperature 90°C

Cable section	Ambient temperature				
	30 °C	40 °C	45 °C	50 °C	55 °C
25 mm <sup>2</sup>	< 135 A	< 123 A	< 117 A	< 110 A	< 103 A
35 mm <sup>2</sup>	< 169 A	< 154 A	< 147 A	< 139 A	< 128 A
50 mm <sup>2</sup>	< 207 A	< 188 A	< 180 A	< 170 A	< 157 A
70 mm <sup>2</sup>	< 268 A	< 244 A	< 233 A	< 220 A	< 204 A
95 mm <sup>2</sup>	< 328 A	< 298 A	< 285 A	< 269 A	< 249 A
120 mm <sup>2</sup>	< 383 A	< 349 A	< 333 A	< 314 A	< 291 A
150 mm <sup>2</sup>	< 444 A	< 404 A	< 386 A	< 364 A	< 337 A
185 mm <sup>2</sup>	< 510 A	< 464 A	< 443 A	< 418 A	< 388 A
240 mm <sup>2</sup>	< 607 A	< 552 A	< 528 A	< 498 A	< 461 A
300 mm <sup>2</sup>	< 703 A	< 639 A	< 611 A	< 576 A	< 534 A
400 mm <sup>2</sup>	< 823 A	< 749 A	< 716 A	< 674 A	< 625 A

**Calculation method for IEC:**

- Single supply cables (3 phases + PE - configuration (1)):
  - Add 10 % to the total compressor current ( $I_{tot}Pack$  or  $I_{tot}FF$  from the tables)
  - Install the prescribed fuse on each cable
- Parallel supply cable (2 x 3 phases + PE - configuration (2)):

- Add 10 % to the total compressor current ( $I_{tot}^{Pack}$  or  $I_{tot}^{FF}$  from the tables) and divide by 2
- Multiply the ampacity of the cables with 0.8 (see table A.52.17 (52-E1))
- Install fuses of half the size of the recommended maximum fuse size on each cable.
- When using 2 x 3 phases + PE as in (3):
  - Add 10 % to the total compressor current ( $I_{tot}^{Pack}$  or  $I_{tot}^{FF}$  from the tables) and divide by  $\sqrt{3}$
  - Multiply the ampacity of the cables with 0.8 (see table A.52.17 (52-E1))
  - Fuse size: the recommended maximum fuse size divided by  $\sqrt{3}$  on each cable.
- Size of the PE cable:
  - For supply cables up to 35 mm<sup>2</sup>: same size as supply cables
  - For supply cables larger than 35 mm<sup>2</sup>: half the size of the supply wires

Always check the voltage drop over the cable (less than 5 % of the nominal voltage is recommended).

- **Example:**  $I_{tot} = 234$  A, maximum ambient temperature is 45 °C, recommended fuse = 315 A
  - Single supply cables (3 phases + PE - configuration (1)):
    - $I = 234 \text{ A} + 10 \% = 234 \times 1.1 = 257.4$  A
    - The table for method F, 70 °C cable temperature and ambient temperature of 45 °C allows a maximum current of 323 A for a 185 mm<sup>2</sup> cable. So use a 3 x 185 mm<sup>2</sup> + 95 mm<sup>2</sup> cable.
    - If the table for method F, 90 °C cable temperature and ambient temperature of 45 °C is used, 120 mm<sup>2</sup> is sufficient. So a single cable 3 x 120 mm<sup>2</sup> + 70 mm<sup>2</sup> is sufficient .
  - Parallel supply cable (2 x 3 phases + PE - configuration (2)):
    - $I = (234 \text{ A} + 10 \%)/2 = (234 \times 1.1)/2 = 128.7$  A
    - Install 160 A fuses on each cable instead of 315 A.
    - For a cable of 95 mm<sup>2</sup>, method F, 70 °C cable temperature and ambient temperature of 45 °C, the maximum current is 209 A x 0.8 = 167.2 A. So 2 parallel cables of 3 x 95 mm<sup>2</sup> + 50 mm<sup>2</sup> are sufficient.
    - For a cable of 95 mm<sup>2</sup>, method F, 90 °C cable temperature and ambient temperature of 45 °C, the maximum current is 233 A x 0.8 = 186.4 A. So 2 parallel cables of 3 x 70 mm<sup>2</sup> + 35 mm<sup>2</sup> are sufficient.

### Cable sizing according UL/cUL

Calculation method according UL 508A, table 28.1 column 5: allowable ampacities of insulated copper conductors (75 °C (167 °F)).

Maximum allowed current in function of the wire size

AWG or kcmil	Maximum current
10	< 30 A
8	< 50 A
6	< 65 A
4	< 85 A
3	< 100 A
2	< 115 A
1	< 130 A
1/0	< 150 A

AWG or kcmil	Maximum current
2/0	< 175 A
3/0	< 200 A

**Calculation method for UL:**

- Single supply cables (3 phases + 1 PE - configuration (1)):
  - Add 25 % to the total current from the tables (see UL 508A 28.3.2: "Ampacity shall have 125 % of the full load current")
  - Install the prescribed maximum fuse on each cable
- Parallel supply cable (2 x 3 phases + 2 PE - configuration (2)):
  - Add 25 % to the total current from the tables and divide by 2
  - Multiply the ampacity of the cables with 0.8 (see UL 508A table 28.1 continued)
  - Install fuses of half the size of the recommended maximum fuse size on each cable.
- When using 2 x 3 phase + 2 PE as in (3):
  - Add 25 % to the total current from the tables and divide by  $\sqrt{3}$
  - Multiply the ampacity of the cables with 0.8 (see UL 508A table 28.1 continued)
  - Fuse size: the recommended maximum fuse size divided by  $\sqrt{3}$  on each cable.
- Size PE cable:
  - For supply cables up to AWG8: same size as the supply cables
  - For supply cables larger than AWG8: use maximum allowed ampacity of the selected supply cables and compare with value in table below (see CEC Part 1 table 17)

< 100 A: use AWG8
< 200 A: use AWG6
< 300 A: use AWG4

Always check the voltage drop over the cable (less than 5 % of the nominal voltage is recommended).

**Example of supply cable calculation:**  $I_{tot} = 128$  A, maximum ambient temperature is 45 °C, recommended fuse = 150 A

- Single supply cables (3 phases + 1 PE - configuration (1)):
  - $I = 128$  A + 25 % =  $128 \times 1.25 = 160$  A
  - For AWG2/0, the maximum current is 175 A, which is sufficient => use AWG2/0
  - Install the prescribed maximum fuse (150 A) on each cable
- Parallel supply cable (2 x 3 phases + 2 PE - configuration (2)):
  - $I = (128$  A + 25%)/2 =  $(128 \times 1.25)/2 = 80$  A
  - For a AWG4, the maximum current is 85 A x 0.8 = 68 A, which is insufficient. For an AWG3, the maximum current is 100 x 0.8 = 80 A. So 2 parallel cables of 3 x AWG3 + 2 x AWG8 are sufficient.
  - Install 80 A fuses on each cable.

## 10.3 Protection settings

### Setting motor overload relay (F21)

Frequency (Hz)	Voltage (V)	30kW F21 (A)	37kW F21 (A)	45kW F21 (A)
IEC				

Frequency (Hz)	Voltage (V)	30kW F21 (A)	37kW F21 (A)	45kW F21 (A)
50	230	73	84	104
60	230	75	85	106
60	380	45	53	64
50	400	42	50	60
60	460	37	44	53
50	500	34	39	48
UL/cUL				
60	230	68	77	96.3
60	460	34	40	48.5
60	575	27.4	32	38.5

### Settings for fan motor overload protection (Q15)

Frequency (Hz)	Voltage (V)	30kW Q15 (A)	37kW Q15 (A)	45kW Q15 (A)
IEC				
50	230	4.7	4.7	4.7
60	230	4.2	4.2	5.8
60	380	2.4	2.4	3.5
50	400	2.7	2.7	2.7
60	460	2.4	2.4	3.2
50	500	2.2	2.2	2.2
UL/cUL				
60	230	4.2	4.2	5.8
60	460	2.4	2.4	3.2
60	575	1.9	1.9	2.6

## 10.4 Dryer switches

### General

The regulating and safety devices are factory-adjusted to give optimum performance of the dryer. Do not alter the setting of any of the devices.

## 10.5 Reference conditions and limitations

### Reference conditions

Air inlet pressure (absolute)	bar	1
Air inlet pressure (absolute)	psi	14.5
Air inlet temperature	°C	20

Air inlet temperature	°F	68
Relative humidity	%	0
Working pressure		See section Compressor data.

**Limits**

Maximum working pressure		See section Compressor data.
Minimum working pressure	bar(e)	4
Minimum working pressure	psig	58
Maximum air inlet temperature	°C	46
Maximum air inlet temperature	°F	115
Minimum ambient temperature	°C	0
Minimum ambient temperature	°F	32

**10.6 Compressor data**

**Reference conditions**

	All data specified below apply under reference conditions, see section <a href="#">Reference conditions and limitations</a> .
---	---

GA 30<sup>+</sup>

		<b>7.5 bar</b>	<b>8.5 bar</b>	<b>10 bar</b>	<b>13 bar</b>	<b>100 psi</b>	<b>125 psi</b>	<b>150 psi</b>	<b>175 psi</b>
Frequency	Hz	50	50	50	50	60	60	60	60
Maximum (unloading) pressure	bar(e)	7.5	8.5	10	13	7.4	9.1	10.8	12.5
Maximum (unloading) pressure	psig	109	123	145	189	107	132	157	181
Maximum (unloading) pressure, units with integrated dryer	bar(e)	7.3	8.3	9.8	12.8	7.2	8.9	10.6	12.3
Maximum (unloading) pressure, units with integrated dryer	psig	106	120	142	186	104	129	154	178
Reference working pressure	bar(e)	7	8	9.5	12.5	6.9	8.6	10.3	12
Reference working pressure	psig	102	116	138	181	100	125	150	175
Pressure drop over dryer, units with integrated dryer	bar(e)	0.25	0.25	0.25	0.25	0.25	0.25	0.25	0.25
Pressure drop over dryer, units with integrated dryer	psig	3.6	3.6	3.6	3.6	3.6	3.6	3.6	3.6

		7.5 bar	8.5 bar	10 bar	13 bar	100 psi	125 psi	150 psi	175 psi
Set point of thermostatic valve	°C	40	40	40	60	40	40	40	60
Set point of thermostatic valve	°F	104	104	104	140	104	104	104	140
Motor shaft speed	r/min	2956	2956	2956	2956	3565	3565	3565	3565
Nominal motor power	kW	30	30	30	30	30	30	30	30
Nominal motor power	hp	40.2	40.2	40.2	40.2	40.2	40.2	40.2	40.2
Temperature of air leaving outlet valve	°C	27	27	27	27	27	27	27	27
Temperature of air leaving outlet valve	°F	81	81	81	81	81	81	81	81
Pressure dew point, units with integrated dryer	°C	3	3	3	3	3	3	3	3
Pressure dew point, units with integrated dryer	°F	37.4	37.4	37.4	37.4	37.4	37.4	37.4	37.4
Temperature of air leaving outlet valve, units with integrated dryer	°C	23	23	23	23	23	23	23	23
Temperature of air leaving outlet valve, units with integrated dryer	°F	73	73	73	73	73	73	73	73
Dryer power at full load, units with integrated dryer	kW	1.4	1.4	1.4	1.4	1.6	1.6	1.6	1.6
Dryer power at full load, units with integrated dryer	hp	1.9	1.9	1.9	1.9	2.1	2.1	2.1	2.1
Dryer power at no load, units with integrated dryer	kW	1.2	1.2	1.2	1.2	1.4	1.4	1.4	1.4
Dryer power at no load, units with integrated dryer	hp	1.6	1.6	1.6	1.6	1.9	1.9	1.9	1.9
Refrigerant type, units with integrated dryer		R410A	R410A	R410A	R410A	R410A	R410A	R410A	R410A
Refrigerant quantity, units with integrated dryer	kg	0.8	0.8	0.8	0.8	0.9	0.9	0.9	0.9
Refrigerant quantity, units with integrated dryer	lb	1.8	1.8	1.8	1.8	1.9	1.9	1.9	1.9
Oil capacity	l	16.4	16.4	16.4	16.4	16.4	16.4	16.4	16.4
Oil capacity	US gal	4.12	4.12	4.12	4.12	4.12	4.12	4.12	4.12
Sound pressure level (according to ISO 2151 (2004))	dB(A)	66	66	66	66	66	66	66	66

## GA 37

		7.5 bar	8.5 bar	10 bar	13 bar	100 psi	125 psi	150 psi	175 psi
Frequency	Hz	50	50	50	50	60	60	60	60
Maximum (unloading) pressure	bar(e)	7.5	8.5	10	13	7.4	9.1	10.8	12.5
Maximum (unloading) pressure	psig	109	123	145	189	107	132	157	181
Maximum (unloading) pressure, units with integrated dryer	bar(e)	7.3	8.3	9.8	12.8	7.2	8.9	10.6	12.3
Maximum (unloading) pressure, units with integrated dryer	psig	106	120	142	186	104	129	154	178
Reference working pressure	bar(e)	7	8	9.5	12.5	6.9	8.6	10.3	12
Reference working pressure	psig	102	116	138	181	100	125	150	175
Pressure drop over dryer, units with integrated dryer	bar(e)	0.25	0.25	0.25	0.25	0.25	0.25	0.25	0.25
Pressure drop over dryer, units with integrated dryer	psig	3.6	3.6	3.6	3.6	3.6	3.6	3.6	3.6
Set point of thermostatic valve	°C	40	40	40	60	40	40	40	60
Set point of thermostatic valve	°F	104	104	104	140	104	104	104	140
Motor shaft speed	r/min	2956	2956	2956	2956	3565	3565	3565	3565
Nominal motor power	kW	37	37	37	37	37	37	37	37
Nominal motor power	hp	49.6	49.6	49.6	49.6	49.6	49.6	49.6	49.6
Temperature of air leaving outlet valve	°C	27	27	27	27	27	27	27	27
Temperature of air leaving outlet valve	°F	81	81	81	81	81	81	81	81
Pressure dew point, units with integrated dryer	°C	3	3	3	3	3	3	3	3
Pressure dew point, units with integrated dryer	°F	37.4	37.4	37.4	37.4	37.4	37.4	37.4	37.4
Temperature of air leaving outlet valve, units with integrated dryer	°C	23	23	23	23	23	23	23	23
Temperature of air leaving outlet valve, units with integrated dryer	°F	73	73	73	73	73	73	73	73
Dryer power at full load, units with integrated dryer	kW	1.34	1.4	1.4	1.4	1.6	1.6	1.6	1.6

		<b>7.5 bar</b>	<b>8.5 bar</b>	<b>10 bar</b>	<b>13 bar</b>	<b>100 psi</b>	<b>125 psi</b>	<b>150 psi</b>	<b>175 psi</b>
Dryer power at full load, units with integrated dryer	hp	1.8	1.9	1.9	1.9	2.2	2.1	2.1	2.1
Dryer power at no load, units with integrated dryer	kW	1.2	1.2	1.2	1.2	1.4	1.4	1.4	1.4
Dryer power at no load, units with integrated dryer	hp	1.6	1.6	1.6	1.6	1.9	1.9	1.9	1.9
Refrigerant type, units with integrated dryer		R410A	R410A	R410A	R410A	R410A	R410A	R410A	R410A
Refrigerant quantity, units with integrated dryer	kg	1	0.8	0.8	0.8	1	0.9	0.9	0.9
Refrigerant quantity, units with integrated dryer	lb	2.1	1.8	1.8	1.8	2.2	1.9	1.9	1.9
Oil capacity	l	17.7	17.7	17.7	17.7	17.7	17.7	17.7	17.7
Oil capacity	US gal	4.12	4.12	4.12	4.12	4.12	4.12	4.12	4.12
Sound pressure level (according to ISO 2151 (2004))	dB(A)	67	67	67	67	67	67	67	67

GA 45

		<b>7.5 bar</b>	<b>8.5 bar</b>	<b>10 bar</b>	<b>13 bar</b>	<b>100 psi</b>	<b>125 psi</b>	<b>150 psi</b>	<b>175 psi</b>
Frequency	Hz	50	50	50	50	60	60	60	60
Maximum (unloading) pressure	bar(e)	7.5	8.5	10	13	7.4	9.1	10.8	12.5
Maximum (unloading) pressure	psig	109	123	145	189	107	132	157	181
Maximum (unloading) pressure, units with integrated dryer	bar(e)	7.3	8.3	9.8	12.8	7.2	8.9	10.6	12.3
Maximum (unloading) pressure, units with integrated dryer	psig	106	120	142	186	104	129	154	178
Reference working pressure	bar(e)	7	8	9.5	12.5	6.9	8.6	10.3	12
Reference working pressure	psig	102	116	138	181	100	125	150	175
Pressure drop over dryer, units with integrated dryer	bar(e)	0.25	0.25	0.25	0.25	0.25	0.25	0.25	0.25
Pressure drop over dryer, units with integrated dryer	psig	3.6	3.6	3.6	3.6	3.6	3.6	3.6	3.6
Set point of thermostatic valve	°C	40	40	40	60	40	40	40	60

		7.5 bar	8.5 bar	10 bar	13 bar	100 psi	125 psi	150 psi	175 psi
Set point of thermostatic valve	°F	104	104	104	140	104	104	104	140
Motor shaft speed	r/min	2956	2956	2956	2956	3565	3565	3565	3565
Nominal motor power	kW	45	45	45	45	45	45	45	45
Nominal motor power	hp	60.4	60.4	60.4	60.4	60.4	60.4	60.4	60.4
Temperature of air leaving outlet valve	°C	27	27	27	27	27	27	27	27
Temperature of air leaving outlet valve	°F	81	81	81	81	81	81	81	81
Pressure dew point, units with integrated dryer	°C	3	3	3	3	3	3	3	3
Pressure dew point, units with integrated dryer	°F	37.4	37.4	37.4	37.4	37.4	37.4	37.4	37.4
Temperature of air leaving outlet valve, units with integrated dryer	°C	23	23	23	23	23	23	23	23
Temperature of air leaving outlet valve, units with integrated dryer	°F	73	73	73	73	73	73	73	73
Dryer power at full load, units with integrated dryer	kW	1.34	1.34	1.4	1.4	1.6	1.6	1.6	1.6
Dryer power at full load, units with integrated dryer	hp	1.8	1.8	1.9	1.9	2.2	2.1	2.1	2.1
Dryer power at no load, units with integrated dryer	kW	1.2	1.2	1.2	1.2	1.4	1.4	1.4	1.4
Dryer power at no load, units with integrated dryer	hp	1.6	1.6	1.6	1.6	1.9	1.9	1.9	1.9
Refrigerant type, units with integrated dryer		R410A	R410A	R410A	R410A	R410A	R410A	R410A	R410A
Refrigerant quantity, units with integrated dryer	kg	1	1	0.8	0.8	1	0.9	0.9	0.9
Refrigerant quantity, units with integrated dryer	lb	2.1	2.1	1.8	1.8	2.2	1.9	1.9	1.9
Oil capacity	l	19	19	19	19	19	19	19	19
Oil capacity	US gal	4.39	4.39	4.39	4.39	4.39	4.39	4.39	4.39
Sound pressure level (according to ISO 2151 (2004))	dB(A)	68	68	68	68	68	68	68	68

## 10.7 Technical data controller

### General

Supply voltage	24 V AC /16 VA 50/60Hz (+40%/-30%) 24 V DC/0.7 A
Type of protection	IP54 (front) IP21 (back)
Ambient and temperature conditions	IEC60068-2
<ul style="list-style-type: none"> <li>• Operating temperature range</li> <li>• Storage temperature range</li> </ul>	<ul style="list-style-type: none"> <li>• -10°C.....+60°C (14 °F .....140 °F)</li> <li>• -30°C.....+70°C (-22 °F .....158 °F)</li> </ul>
Permissible humidity	Relative humidity 90% No condensation
Noise emission	IEC61000-6-3
Noise immunity	IEC61000-6-2
Mounting	Cabinet door

### Digital outputs

Number of outputs	6 (Elektronikon™ controller - p.n. 1900 5200 00 .... 1900 5200 09) 9 (Elektronikon™ Graphic controller - p.n. 1900 5200 10 .... 1900 5200 19)
Type	Relay (voltage free contacts)
Rated voltage AC	250 V AC / 10 A max.
Rated voltage DC	30 V DC / 10 A max.

### Digital inputs

Number of inputs	4 (Elektronikon™ controller - p.n. 1900 5200 00 .... 1900 5200 09) 10 (Elektronikon™ Graphic controller - p.n. 1900 5200 10 .... 1900 5200 19)
Supply by controller	24 V DC
Supply protection	Short circuit protected to ground
Input protection	Not isolated

### Analog inputs

Number of pressure inputs	1 (Elektronikon™ controller - p.n. 1900 5200 00 .... 1900 5200 09) 2 (Elektronikon™ Graphic controller - p.n. 1900 5200 10 .... 1900 5200 19)
Number of temperature inputs	3 (Elektronikon™ controller - p.n. 1900 5200 00 .... 1900 5200 09) 5 (Elektronikon™ Graphic controller - p.n. 1900 5200 10 .... 1900 5200 19)

## 11 Instructions for use

### Oil separator vessel

This vessel can contain pressurized air. This can be potentially dangerous if the equipment is misused.
This vessel must only be used as a compressed air/oil separator tank and must be operated within the limits specified on the data plate.
No alterations must be made to this vessel by welding, drilling or other mechanical methods without the written permission of the manufacturer.
The pressure and temperature of this vessel must be clearly indicated.
The safety valve must correspond with pressure surges of 1.1 times the maximum allowable operating pressure. It should guarantee that the pressure will not permanently exceed the maximum allowable operating pressure of the vessel.
Use only oil as specified by the manufacturer.

## 12 Guidelines for inspection

### Guidelines

On the Declaration of Conformity / Declaration by the Manufacturer, the harmonised and/or other standards that have been used for the design are shown and/or referred to.

The Declaration of Conformity / Declaration by the Manufacturer is part of the documentation that is supplied with this compressor.

Local legal requirements and/or use outside the limits and/or conditions as specified by the manufacturer may require other inspection periods as mentioned below.

## 13 Pressure equipment directives

### Components subject to 2014/68/EU Pressure Equipment Directive

The following table contains the necessary information for the inspection of all pressure equipment of category II and higher according to the Pressure Equipment Directive 2014/68/EU and all pressure equipment according to the Simple Pressure Vessel Directive 2014/29/EU.

Compressor type	Component	Description	Volume	Design pressure	Minimum and maximum design temperature	PED Class
GA 30 <sup>+</sup> up to GA 45	1625 430224	Vessel	30l	15 bar(e)	-10 °C/ 120 °C	II
	0830 101068	Safety valve	-	-	-	IV
	0830 101069	Safety valve	-	-	-	IV

Compressor type	Component	Description	Number of cycles (1)	Minimum wall thickness	Inspection frequency (2)
GA 30 <sup>+</sup> up to GA 45	1625 5641 99	Vessel	2 x 10 <sup>6</sup>	8 mm	10 years
	0830 1010 68	Safety valve	-	-	-
	0830 1010 69	Safety valve	-	-	-

The compressors conform to PED smaller than category II.

(1) The number of cycles refers to the number of cycles from 0 bar(e) to maximum pressure.

(2) The minimum wall thickness must be respected at all times. Inspection techniques such as ultrasonic or X-ray are equivalent to hydrostatic testing for this equipment.

# 14 Declaration of conformity

Insert logo here

## EU DECLARATION OF CONFORMITY

- 1
- 2 We, (1) declare under our sole responsibility, that the product
- 3 Machine name :
- 4 Machine type :
- 5 Serial number :
- 6 Which falls under the provisions of article 12.2 of the EC Directive 2006/42/EC on the approximation of the laws of the Member States relating to machinery, is in conformity with the relevant Essential Health and Safety Requirements of this directive.

The machinery complies also with the requirements of the following directives and their amendments as indicated.

7

	Directive on the approximation of laws of the Member States relating to	Harmonized and/or Technical Standards used	Att'mnt
a	(2)	(3)	
b			X
c			
d			X
e			
f			
g			X

- 8a The harmonized and the technical standards used are identified in the attachments hereafter
- 8b <1> is authorized to compile the technical file.
- |              |  |  |
|--------------|--|--|
|              | <b>Conformity of the specification to the directives</b> | <b>Conformity of the product to the specification and by implication to the directives</b> |
| 11 Issued by | Engineering  | Manufacturing  |
| 12           |  |  |
| 13 Name      |  |  |
| 14 Signature |  |  |
| 15 Date      |  |  |
| 16 Place     |  |  |
| 17           |  |  |

84950D

*Typical example of a Declaration of Conformity document*

(1): Contact address:

Atlas Copco Airpower n.v.  
 P.O. Box 100  
 B-2610 Wilrijk (Antwerp)  
 Belgium

(2): Applicable directives

(3): Standards used

On the Declaration of Conformity / Declaration by the Manufacturer, the harmonized and/or other standards that have been used for the design are shown and/or referred to.

The Declaration of Conformity / Declaration by the Manufacturer is part of the documentation that is supplied with this device.





## ***COMMITTED TO SUSTAINABLE PRODUCTIVITY***

We stand by our responsibilities towards our customers, towards the environment and the people around us. We make performance stand the test of time. This is what we call — Sustainable Productivity.

[www.atlascopco.com](http://www.atlascopco.com)

